

**THE TREATMENT OF KINSHIP
TERMINOLOGY IN SOTHO DICTIONARIES,
WITH SPECIAL REFERENCE TO SETSWANA**

BY

BONTSI TJANANA MOLALAPATA

Submitted in fulfillment of the requirements for the degree of

MASTER OF ARTS

IN THE SUBJECT

LEXICOGRAPHY

at the

UNIVERSITY OF PRETORIA

**SUPERVISOR: PROF D J PRINSLOO
CO-SUPERVISOR: R M RAMAGOSHI**

FEBRUARY 2004

TABLE OF CONTENTS

Acknowledgements	i
Summary	ii
Samevatting	iii
List of keywords	iv
Abbreviations	iv
List of tables	iv

CHAPTER 1: INTRODUCTION

1.1	Background to the study	1
1.2	Aim of the study	1
1.3	Problem statement	2
1.4	Research methodology	2
1.5	Scope of the study	5
1.6	Conclusion	6

CHAPTER 2: THEORETICAL FRAMEWORK

2.1	Introduction	7
2.2	What is kinship	7
2.3	Variation of kinship	9
2.3.1	Pseudo kinship	9
2.3.2	Kinship and descent	10
2.3.3	Kinship and marriage	11
2.4	Kinship roles	12
2.5	Models employed in the analysis of kinship	13
2.6	Terminology and Structure	14
2.7	Theory on dictionary entries	16
2.8	Conclusion	17

CHAPTER 3: DIAGRAMS AND TABLES SHOWING MAN'S RELATIVES

3.1	Introduction	18
3.2	Man's parents on the father's side	18
3.3	Man's father's brothers and sisters	24
3.4	Relationship between two (2) family generations	29
3.5	Relationship between two (2) generations, man's father's brothers and sisters, with their children	35

3.6	Relationship between man's own children's parents -in-law	41
3.7	Man's own children and their families	46
3.8	Man's brothers' and sisters' children	51
3.9	Man's grandchildren	56
3.10	Man's grandparents on the mother's side	62
3.11	Man's mother's brothers and sisters	66
3.12	Man's mother's brothers and sisters' children	72
3.13	Conclusion	77

CHAPTER 4: DIAGRAMS AND TABLES SHOWING MAN'S WIFE'S RELATIVES

4.1	Introduction	79
4.2	Wife's grandparents on the father's side	79
4.3	Wife's father's brothers and sisters	84
4.4	Wife's own brothers and sisters	90
4.5	Wife's father's brothers and sisters' children	96
4.6	Wife's brothers and sisters' children	101
4.7	Wife's grandparents on the mother's side	105
4.8	Wife's mother's brothers and sisters	110
4.9	Wife's mother's brothers and sisters' children	114
4.10	Conclusion	119

CHAPTER 5: MONO-LINGUAL GLOSSARY OF KINSHIP TERMS IN SETSWANA

5.1	Introduction	120
5.2	Terms	120
5.3	Conclusion	122

CHAPTER 6: SUMMARY, RECOMMENDATIONS AND CONCLUSION

6.1	Introduction	123
6.2	Summary of the study	123
6.2.1	The quality of entries	123
6.2.2	Issues raised in the problem statement	124
6.3	Recommendations	125
6.4	Conclusion	125
	Bibliography	127
	Appendix	131

ACKNOWLEDGEMENTS

I would like to express my sincere gratitude to the people who contributed to the success of this dissertation. Without their support, encouragement and guidance, I could have failed. Above all, I thank the Almighty God. I thank my supervisor Professor D. J. Prinsloo, for his professional guidance and especially his patience and willingness throughout the production of this study. It was through his constructive comments and advice that I managed to complete this work. To Ms Refilwe Ramagoshi, my co-supervisor, I express my greatest gratitude for all your assistance. Her support and encouragement kept me going and I would not have achieved much without her. Again, special thanks to Ms Susan Brock who helped with the editing of my document.

I wish to express my love and appreciation to my dear mother, Mrs Baatweng Molalapata, who supported me all the way, making sacrifices where no one else but a loving and caring mother would. I also thank my five sisters, Mrs S. T. Mollowakgotla, Mrs G. S. Sono, Mrs U. K. Van Vuuren, Mrs S. G. Nkaelang, and Mrs G. K. Mokopakgosi, together with my niece Boitumelo Sosome, I appreciate their encouragement. This extends to all members of my family and friends, especially Mrs Baitso Moatlhodi and Mrs Cannie Seleka. I am so grateful.

Lastly but not least, I would like to thank my dearest husband, Elijah Masedi together with our two daughters, Lorato and Wame, for their understanding and compromise during my long stay away from home. The success of my study has been based on their cooperation. God bless my family.

SUMMARY

The study on kinship terminology is concerned with the treatment of terms in dictionaries. Studies of this nature have been undertaken about several African languages, but such studies on Setswana were limited and were done a long time ago. The motive behind looking at kinship terms is that the researcher, being a native speaker of Setswana, has realised that entries of kinship terms in dictionaries are not satisfactory or, in some cases, do not exist at all.

The study is aimed at investigating entries of Setswana kinship terms and evaluating their appropriateness. There are cases where no entries exist, hence the researcher intends to come up with definitions for such terms. In cases of ambiguity, that is, where a term can be used to refer to more than one relation, the researcher will identify the other instances where such a term can be used. In addition, the researcher aims at comparing Setswana with other Sotho languages. There are cases where these languages use borrowed words because of their integration with other languages in their localities, especially with Afrikaans.

The study is divided into six chapters. The first deals with the introduction to the study of Setswana kinship terminology, the statement of the problem, aim of the study, research methodology and the scope of the study. The second chapter deals with the theoretical background of kinship. Chapter 3 covers kinship terminology with reference to the man's family. The treatment of kinship terms in dictionaries is also discussed. Chapter 4 is almost similar to the preceding chapter, but deals with kinship terminology pertaining to the man's wife's relatives. The fifth chapter provides a mono-lingual glossary of kinship terminology in Setswana. The sixth and last chapter contains the conclusion as well as recommendations by the researcher.

SAMEVATTING

Die studie van verwantskapsterminologie is gemoeid met die bewerking van terme in woordeboeke. Soortgelyke studies is al in verskeie Afrikatale onderneem, maar in Setswana is dit dun gesaai en ook lank terug gedoen. Die rasionaal agter die studie van verwantskapsterme is dat die navorser, 'n Setswana moedertaalspreker, beseft het dat die hantering van verwantskapsterme in woordeboeke nie bevredigend is nie en dat hierdie terme in sommige gevalle glad nie opgeneem is nie.

Die studie is 'n ondersoek na die hantering van Setswana verwantskapsterminologie in woordeboeke om die toepaslikheid daarvan te bepaal. In gevalle van dubbelsinnigheid, dit is, wanneer 'n term gebruik kan word om na meer as een verwantskapsrelasie te verwys, sal die navorser voorbeelde van die ander gevalle verstrek waar die term gebruik kan word. Die navorser vergelyk ook Setswana met ander Sothotale. Daar is gevalle waar hierdie tale leenwoorde gebruik as gevolg van hulle kontak met ander tale, veral Afrikaans.

Die studie word verdeel in ses hoofstukke. Die eerste hoofstuk bevat 'n inleiding tot die studie van Setswana verwantskapsterminologie, die probleemstelling, die doel van die studie, navorsingsmetodologie en laastens die studieveld. Die tweede hoofstuk handel oor die teoretiese agtergrond van verwantskap. Hoofstuk drie behandel verwantskapsterme met verwysing na die man se familie. Die hantering van verwantskapsterme in woordeboeke word ook gedek. Hoofstuk vier is byna eenders as die voorafgaande hoofstuk, maar handel oor verwantskapsterminologie aangaande die man se vrou se familie. Die vyfde hoofstuk bied 'n eentalige woordelys van verwantskapsterminologie in Setswana. Die sesde en laaste hoofstuk sluit sowel gevolgtrekking as aanbevelings deur die navorser in.

KEYWORDS

Brother

Sister

Relationship

Aunt

Kinship

Nephew

Generation

Children

Niece

Uncle

ABBREVIATIONS

Ego = self; center of the interpretation; starting point

TG shows intonation :

T = segalo tlase

G = segalo godimo (see Tsonope)

F1 = Generation 1

F2 = Generation 2

LIST OF TABLES

Table 1a	Setswana
Table 1b	Northern Sotho
Table 1c	Southern Sotho
Table 1d	Dictionary entries for terms found in Table 1a
Table 2a	Setswana
Table 2b	Northern Sotho
Table 2c	Southern Sotho
Table 2d	Dictionary entries for terms found in Table 2a
Table 3a	Setswana
Table 3b	Northern Sotho
Table 3c	Southern Sotho
Table 3d	Dictionary entries for terms found in Table 3a

Table 4a	Setswana
Table 4b	Northern Sotho
Table 4c	Southern Sotho
Table 4d	Dictionary entries for terms found in Table 4a
Table 5a	Setswana
Table 5b	Northern Sotho
Table 5c	Southern Sotho
Table 5d	Dictionary entries for terms found in Table 5a
Table 6a	Setswana
Table 6b	Northern Sotho
Table 6c	Southern Sotho
Table 6d	Dictionary entries for terms found in Table 6a
Table 7a	Setswana
Table 7b	Northern Sotho
Table 7c	Southern Sotho
Table 7d	Dictionary entries for terms found in Table 7a
Table 8a	Setswana
Table 8b	Northern Sotho
Table 8c	Southern Sotho
Table 8d	Dictionary entries for terms found in Table 8a
Table 9a	Setswana
Table 9b	Northern Sotho
Table 9c	Southern Sotho
Table 9d	Dictionary entries for terms found in Table 9a
Table 10a	Setswana
Table 10b	Northern Sotho
Table 10c	Southern Sotho
Table 10d	Dictionary entries for terms found in Table 10a
Table 11a	Setswana
Table 11b	Northern Sotho
Table 11c	Southern Sotho
Table 11d	Dictionary entries for terms found in Table 11a
Table 12a	Setswana
Table 12b	Northern Sotho
Table 12c	Southern Sotho
Table 12d	Dictionary entries for terms found in Table 12a

Table 13a	Setswana
Table 13b	Northern Sotho
Table 13c	Southern Sotho
Table 13d	Dictionary entries for terms found in Table 13a
Table 14a	Setswana
Table 14b	Northern Sotho
Table 14c	Southern Sotho
Table 14d	Dictionary entries for terms found in Table 14a
Table 15a	Setswana
Table 15b	Northern Sotho
Table 15c	Southern Sotho
Table 15d	Dictionary entries for terms found in Table 15a
Table 16a	Setswana
Table 16b	Northern Sotho
Table 16c	Southern Sotho
Table 16d	Dictionary entries for terms found in Table 16a
Table 17a	Setswana
Table 17b	Northern Sotho
Table 17c	Southern Sotho
Table 17d	Dictionary entries for terms found in Table 17a
Table 18a	Setswana
Table 18b	Northern Sotho
Table 18c	Southern Sotho
Table 18d	Dictionary entries for terms found in Table 18a
Table 19a	Setswana
Table 19b	Northern Sotho
Table 19c	Southern Sotho
Table 19d	Dictionary entries for terms found in Table 19a

CHAPTER 1

INTRODUCTION

1.1 BACKGROUND TO THE STUDY

This study focuses on the treatment of Setswana kinship terminology in some of the Setswana Dictionaries namely Thanodi ya Setswana by Kgasa and Tsonope (1995). The South African Multi-language Dictionary and Phrase Book by le Roux et al (1996), Dikišinari ya Setswana, English, Afrikaans by Snyman, Shole and le Roux (1990) and The Setswana English Dictionary by Brown (1973). The researcher found it necessary to come up with such a study after observing that some of the kinship terms in Setswana have not been treated in some of the dictionaries. For some that have entries in the dictionaries, the information or entries are limited and need to be updated.

Throughout the study the researcher followed the model employed by Van Wyk and Prinsloo (1992) when they studied the Northern Sotho kinship terminology. As far as other research is concerned, very little has been done in the study of Setswana kinship terminology; what has been done is dealt with under certain cultural issues, like marriage and family life. Mogapi (1991:17) makes an attempt to address kinship terminology, but his main focus is still the family, 'lelwapa' and the kinship terminology that he comes up with serve only to give the readership a background, not a detailed study, as terms like great - grandfather and great - grandmother are not addressed.

1.2 AIM OF THE STUDY

The aim of the study is to give an overall account of kinship terminology in Setswana and to compare it with Northern Sotho and Southern Sotho. In addition the researcher intends to evaluate the treatment of kinship terminology in dictionaries.

1.3 PROBLEM STATEMENT

The specific problem to be researched is the treatment of the Setswana kinship terms which have not been entered in dictionaries, or entered without all their meanings explained. The following subsidiary questions require clarification:

- Does extensive terminology exist to denote kinship?
- Since language is dynamic, is there anything being done to the existing terminology in terms of coming up with new terms or developing existing words.
- What is being done to assist, for example, someone who is learning Setswana, to understand words which do not denote gender like 'mogolole' or 'nkgonne' (elder brother or sister)?
- Which is more dominant, the use of borrowed kinship terminology or native words?
- Should borrowed kinship terms be included in dictionaries of African languages?
- How can we arrive at definitions of certain terms where no single word exists and an expression or phrase is used?

1.4 RESEARCH METHODOLOGY

An in-depth study of dictionaries was undertaken focusing on the treatment of kinship terminology in Setswana. There is a table for each kinship diagram which lists dictionary entries for terms appearing in the diagrams and then evaluates the entries to determine the consistency in naming the kinship terms.

A master diagram given below is a demonstration of the construction of the kinship diagrams used throughout the study.

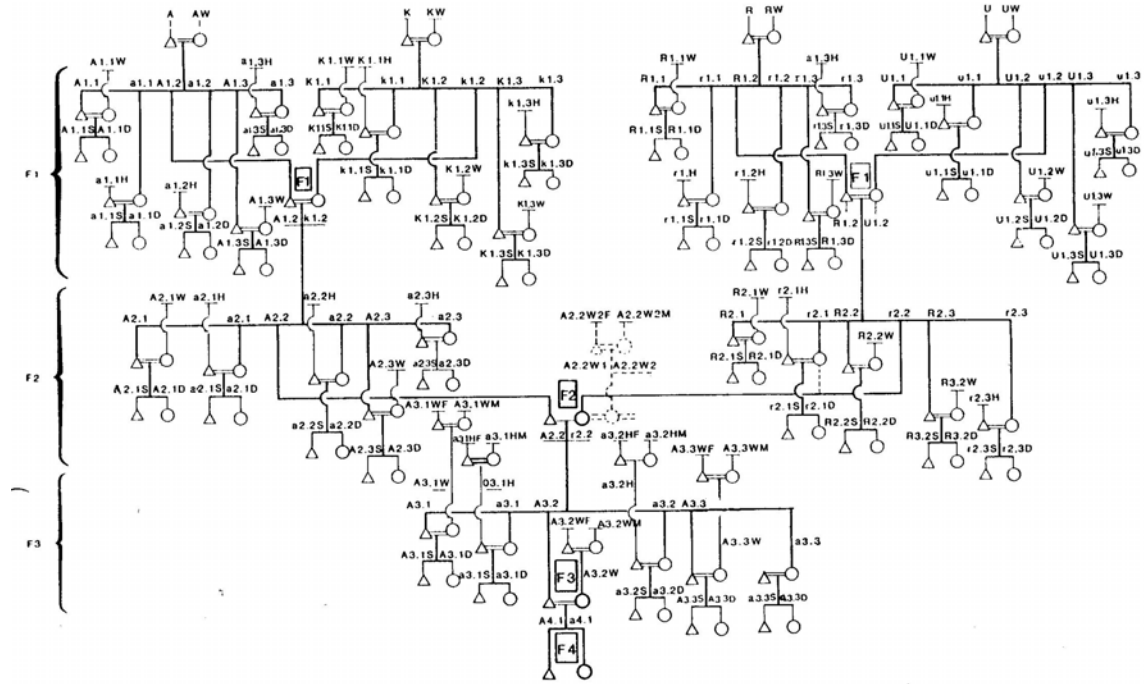

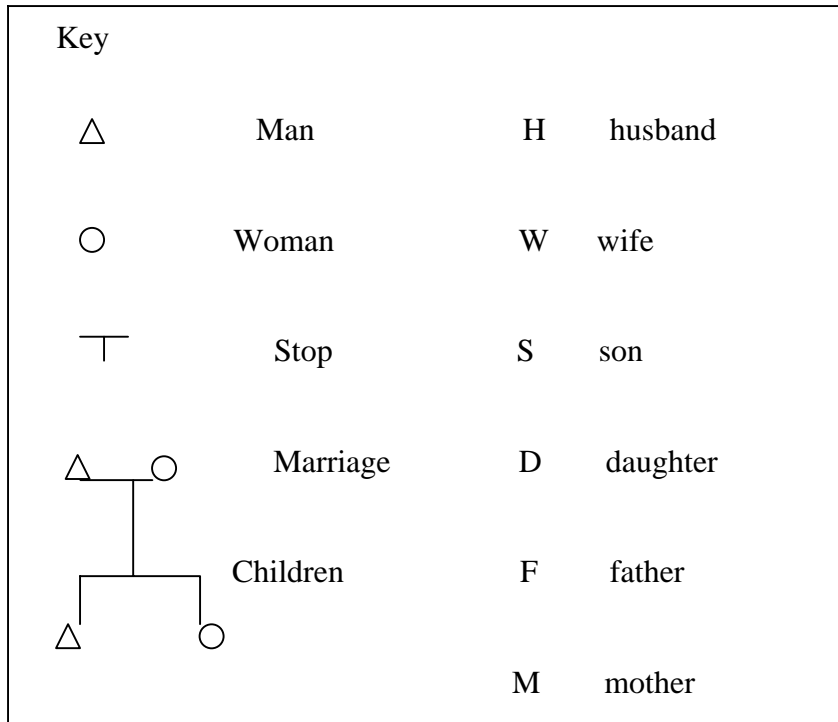

This master diagram has two parts; one dealing with the man's (Ego A2.2) relatives on one side and another showing his wife's (r2.2) relatives. Chapter 3 deals with the diagrams and tables concerning the husband (Ego A2.2) and his relatives, while Chapter, Chapter 4, will address the relatives of his wife (r2.2). Four generations (F1-4) are shown in the master diagram, but the research is going to focus on the F2-generation, where the Ego, A2.2 falls. Initially, the idea of choosing this second generation as the centre from which the interpretation is done came from Van Wyk and Prinsloo (1992:45) during their analysis of the Northern Sotho kinship terminology. The diagram starts with four couples, namely A and AW, K and KW

R and RW, U and UW

Each of these couples bears children, who constitute the first generation, F1. Members of this generation members marry, for instance, A1.2, son of A and AW, marries the daughter of K and KW who is K1.2. This couple bears six children, among them A2.2, and these children constitute the second generation, F2. The focus is on the child, A2.2 marrying r2.2 from the R family. The couple also bears six children, who constitute the third generation, F3. Among these children is son A3.2, who marries A3.2W and they are blessed with two children, A4.1 and his sister a4.4. They make up the fourth and last generation.

The researcher had a chance to solicit information from members of the Southern Sotho Dictionary Unit who were visiting the Department of African Languages at the time of the research. They happened to be native Southern Sotho speakers. They assisted the researcher with comparing and verifying the similarities and differences between Setswana and Southern Sotho kinship terms. The Van Wyk and Prinsloo (1992) study on Northern Sotho kinship terminology was used to validate the differences and similarities between terms in Northern Sotho and Setswana.

Informants were given two family tree diagrams. They were required to fill in the kinship terms (see Appendix) on the diagrams. They were assisted by questions which guided them in filling in the relevant terms as they know them. Additional questions were posed by the researcher to ensure clarity of facts and easy interpretation of the diagrams. Upon collection, six Setswana speakers filled in the kinship terms while three Northern Sotho and three Southern Sotho speakers responded.

1.5 SCOPE OF THE STUDY

The thesis is arranged in the following manner:

Chapter 1

This is an introductory chapter putting all aspects of the thesis into perspective. In this chapter one can find the problem statement and the aim of the research. A brief explanation of the research methodology is also presented.

Chapter 2

In this chapter a theoretical framework of kinship is given. The researcher looks at how different authorities analyse and interpret kinship.

Chapter 3

In this chapter family diagrams and tables of the man's relatives are presented for the Setswana kinship terms and compared with the terms in the other two sister languages.

Chapter 4

This chapter presents the family diagrams and tables which address the kinship terms for the relatives of the man's wife, in the three specified languages.

Chapter 5

This chapter contains a glossary of Setswana kinship terms with their English equivalents.

Chapter 6

This chapter presents the conclusions drawn from the research and makes recommendations for the treatment of kinship terminology in Setswana.

1.6 CONCLUSION

The kinship diagrams completed by respondents were used to analyse the differences and similarities that exist among the three Sotho languages concerning kinship terminology.

CHAPTER 2

THEORETICAL FRAMEWORK

2.1 INTRODUCTION

Kinship comes about as a result of descent, that is, one's kinsmen are one's blood relatives. Several sources of kinship analysis point out that kinship is not just acquired by descent or marriage, but can also be established for a variety of reasons. In this chapter the theory of kinship will be discussed.

2.2 WHAT IS KINSHIP?

Definitions from different dictionaries centre around family or blood relationship;

The Longman Dictionary of Contemporary English defines kinship as “family relationship; likeness in character, understanding etc.” (1990:576).

The Longman Dictionary of English Language and Culture defines it as “family relationship. Likeness in character, understanding, etc.”(1992:351).

Chambers Family Dictionary has it as “blood relationship; similarly in character.”(1981:208).

The Setswana English Setswana Dictionary (Matumo Z I) defines it as “a family; a generation; a relative.”(1987:213).

When defining kinship, Ramagoshi (2000:28) states that it refers to:

The people you are born with, like brothers, sisters plus their children if they have any. It further encompasses your aunts and uncles, those who are born with your parents.

Sometimes, kinship will include stepchildren, even though the blood ties are on the wife's side or the husband's side.

Stone (1998:5) states that:

Kinship is the recognition of a relationship between persons based on descent or marriage. If the relationship between one person and another is considered by them to involve descent, the two are consanguineal (blood) relatives. If the relationship has been established through marriage, it is affinal.

On a similar note, Schaeffer, Lamn & McGraw-Hill (1998: 382), as quoted by Ramagoshi (2000:27) state that “kinship refers to that state of being related to others”.

The different definitions of kinship show that it is based on the nuclear family, which consists of mother, father and their children. This is observed by Schusky (1972:7), who states that:

The nuclear family, consisting of parents and children, is the basis for kinship in nearly all societies, but the organisation and behaviour of members may vary considerably from what Americans and Europeans expect.

With this statement, Schusky (1972) establishes that kinship means the same thing in most cultures, although in some cultures it might be interpreted differently. To some cultures, kinship does not exist only in the nuclear family, but also in extended family. The Concise Oxford Dictionary (1995:353) defines the extended family as:

A family which extends beyond the nuclear family to include relatives, who live nearby or in one household

In the Setswana culture, extended families are regarded as part of the nuclear family, as it is believed that when one marries a man or a woman, one marries his or her family and his or her close relatives too. This belief is embedded in culture and its extension is interpreted differently in different cultures. The following discussion will attempt to address the variations in kinship.

2.3 VARIATIONS OF KINSHIP

2.3.1 Pseudo kinship

Pseudo kinship refers to kinship that is established in some forms/ways other than descent and marriage. Adoption and artificial kinship are examples of pseudo kinship.

a) Adoption

Schusky (1974) states that a child is regarded as adopted if a legal agreement has been entered into between the biological parent(s) and the person(s) willing to adopt the child, or a body or society representing the biological parents may authorize adoption. Once the relationship has been formalised, the adopted child becomes a member of the family and is brought up with all the rights and privileges that cover the other children born in that family.

b) Artificial kinship

The notion that kinship is not only established by descent or marriage is supported by Goody (1973) when he talks of artificial kinship. In a situation where a person (or family) moves to an area populated by people who are not his kinsmen, such a person (or family) may establish ties and relationships with people in the vicinity. These ties may become just as strong as if the people were genealogically kinsmen. Several authorities emphasise relationship as a basis that is used to create kinship terms, regardless of whether the relationship is a result of marriage or descent. (Goody, 1973:78).

Schapera, as quoted by Radcliffe-Brown (1968:142) states that:

It will have been gathered that most of a man's neighbours may be closely related to him, especially in the agnatic line... In addition, he has more distant relatives of all kinds widely scattered over the tribe and even in other tribes, for the Tswana carry recognition of relationship much further than is common in our society. Almost everybody with whom genealogical connexion can be established, no matter in how remote a degree, is considered a kinsman...

The above theorists have observed that kinship can be culturally learned and is not exclusively determined by biological or marital ties. Adoption is given as an example of kinship which is legally acknowledged and socially accepted. In her observation, Ramagoshi (2000:29) asserts that:

From the long list of who constitutes kinship and the types of extended families, one can see that almost the whole village can be made up of kinship and extended families.

2.3.2 Kinship and descent

According to the definitions cited in this study, it is understood that kinship is established as a result of descent, that is, kins are blood relations. Since kinship is an important African norm, kinsmen have an obligation towards one another. Mogapi (1991) states that in the traditional Setswana society for example, the extended family was emphasised more than the nuclear family. It was easy to raise families with relatives living in one household because people were helpful towards one another in a variety of ways. For instance, the grandfather or the eldest member of the family would be considered the link-man between members of the family and the ancestors.

As a result, if there were cultural activities at society or village level, such members would represent the family. An example of such activities would be the organisation of initiation schools. The grandfather would be consulted time and again by the rest of the family regarding those who are due to go for initiation, as well as all the requirements thereof. In return for the respect that the grandfather received from the members of the family, he too would always be supportive and defend the members when the need arose.

Eshleman (1994:95) makes the following comment in this regard:

A kinship system is a pattern of social norms regulating those relationships that are directly based on the birth cycle.... These relationships, whether created biologically or socially, exist among people who descend from one another (parents and children) or who have common descent (brothers and sisters).

2.3.3 Kinship and marriage

A young man leaves his family and finds a young woman from a different family, they get married and, naturally, the families of the two get to know each other better and grow closer. This is the beginning of an extended family in which the members assist each other in the upbringing of their children. In a true African family, different members of a family have responsibilities, which are normally carried out with the utmost diligence and commitment. For example, there are functions that are performed by uncles, that is, the father's brothers as well as those performed by maternal uncles, (mother's brothers).

Normally, if the ties between the relatives are regarded as important, both parties feel recognised and the practice is carried on by their children. For instance, in Setswana, if a child burns an item of clothing by mistake when ironing he or she should give it to his or her aunt and, normally, the latter returns that recognition by buying the child something new. This aspect is emphasised by Keesing (1975:14) when he states that:

Networks that connect individuals as relatives are apparently universally recognised and universally accorded social importance. Note that every individual, other than full siblings, has a unique array of relatives, on mother's and father's sides. Kinship ties serve, then, to define the unique position of each individual in her/his social world – to establish strands of mutual amity and obligation in that individual's own group and in other groups.

2.4 KINSHIP ROLES

Schusky (1972:11) highlights a number of important roles, like economic support of the family or the discipline of children, that socially make one a member of a family. The structure of the nuclear family makes a difference: if there is only one breadwinner, he or she cares for only his or her family members. In this situation, it is the responsibility of the parent(s) to discipline their children, rather than in cases where other members of the parents' relatives are available, who can assist in this regard.

When it comes to certain cultural practices where certain roles have to be played by certain people, then, one of the uncles (malome) may perform the function of father's brother (rangwane). In Setswana, for instance, it is important that when a person has died, the paternal uncle is responsible for finding the right plot for a grave to be dug (Mogapi 1991:13)

2.5 MODELS EMPLOYED IN THE ANALYSIS OF KINSHIP

There are different models employed in the analysis of kinship. The researcher has only used the standard approach which has been used by Van Wyk and Prinsloo (1992) in their analysis. There is also the principle-oriented approach which is used by Boonzaaier (undated article). In his paper, entitled *Kinship terminology among the South Eastern Bantu*, he outlines the principles as:

- Generation: the biological succession of generations in terms of reproduction.
- Relative age: showing that kinship helps in influencing the behaviour of children because of the way youngsters relate with their elders.
- Gender: this refers to how males and females relate towards one another.
- Affinity: looking at blood relationships as compared to relations that come about as a result of marriage, in-laws.
- Co-laterality: children in the same generation may not relate to each other at the same degree, therefore different terminology is used.
- Bifurcation: relation towards ego differs according to whether is on the mother's side or father's side.
- Polarity: there are normally two different reciprocal terms for every party within a relationship to refer to others.
- Speaker's gender: there can be two terms used for the same relation, depending on whether the speaker is a man or a woman.
- Deceased or alive: one term can be used when the blood relative is alive and another term used when the relative is deceased.

Boonzaaier's model is different from that employed by Van Wyk and Prinsloo (1992) who used the standard, basic approach, in their study of the Northern Sotho kinship terminology. Their model involves the use of simple family diagrams which show descent, hence indicating kinship terms used by the relatives to refer to one another. They came up with nineteen relation tables and diagrams from which kinship terms are derived. The researcher intends to use the latter's method because very little has been done in the study of kinship terminology in Setswana. It is imperative to work on

a more standard approach, which will be easy to understand; other factors, like principles on which a study can be made, can be considered at a later stage.

2.6 TERMINOLOGY AND STRUCTURE

Almost all resources on kinship emphasize the use of the term ego as the starting point, the centre from which an analysis is made to be able to come up with kinship terms.

According to Holy (1998:41):

Kindred is an ego-centered kinship category. It may be visualized as a series of concentric circles with the ego in the middle, surrounded by members of her/his nuclear family and beyond then by circles of more distant kinsmen, the knowledge of whom becomes less and less intimate the further removed they are from the ego, and the relationship with whom is seen as being progressively less determined by mutual kinship.

Schusky (1972:11) makes the following comment about terminology:

It must be emphasised throughout the study of kinship that precision in terminology is necessary because native kin terms are clues to behaviour and cognition patterns. Terminology is generally the single best index of behaviour ...

... kinship terminologies have been the richest source of data for semantic analysis and insight into how people think or give meaning to words.

According to Keesing (1975:118) kinship terminologies also shed light on the behaviour of particular persons assigned these names, as they seem to determine the behaviour of those persons. He further says:

A common way of seeking to establish a fit between kinship terminologies and social systems has been to assume that kinship categories label social roles. Those relatives who appropriately act in a particular way vis-a-vis ego – whether that is an avoidance relationship (example ‘mother-in-law’) or an authoritarian one (example ‘father’) or one of closeness and support (example ‘grandfather’) – in a particular system are classed together.

On the other hand, Schapera as cited by Radcliffe-Brown (1968:142) is of the opinion that:

The kinship terminology reflects many, but not all, of the social distinctions. The basic pattern is set by the terms used within the family.

From the above theorists’ opinions, it can be concluded that kinship terms are given in relation to social roles that kinsmen play. It is imperative to know how a person relates with another before a particular term can be attributed to or used to identify that person. The kinship terms attributed best describe the relationship between the people concerned and their different roles. This is practical in a Setswana set-up, for instance where a maternal uncle ‘malome’ can be referred to as ‘rangwane’ (paternal uncle) because of the duties that he performs in that particular family set-up. This normally happens in cases where ‘the father’ does not have a male relative, and coincidentally ‘the mother’ happens to be the only woman born among a number of brothers.

2.7 THEORY ON DICTIONARY ENTRIES

The study is based on the treatment of kinship terms in dictionaries, thus it is important to outline what is expected in a dictionary entry concerning kinship terms. Firstly, it is important to explain what a dictionary is. Gove (1967:15) describes a dictionary as:

An authority in only a relative sense. The moment it has been printed it has become dated and cannot be wholly authoritative for the next moment.

From Gove's remarks we gather that it is not wise to rely wholly on the dictionary because the meaning(s) of items in it may have been applicable at a certain period, but might be overcome by events, hence, it cannot be said to be reliable after a certain period has passed.

On the other hand, Shaw (1987:127) defines a dictionary as:

A book containing a selection of words, usually arranged alphabetically, concerning which information about meanings, pronunciation, etymologies and a wealth of other detail provided.

On a similar note, Hartmann (2001:12) gives several definitions for a dictionary, putting emphasis on it being a book of reference with a selection of words. This brings to attention the fact that some of the dictionaries in Setswana have limited entries for kinship terms. Hartmann (2001:2) attributes this to the fact that the purpose and intended function of a particular dictionary may restrict the dictionary author from giving general definitions of terms which will satisfy a wide readership.

There are other factors that can hinder a dictionary author to produce a masterpiece.

Kiango (2000:11) mentions some of these factors which are particularly evident in African societies. In the case of Setswana, for instance, a number of dictionaries have to be bilingual (Setswana – English) because, a monolingual Setswana piece of work would not be of any contribution internationally.

2.8 CONCLUSION

The above discussions indicate that among Africans, kinship is an important cultural practice, and kinship terminology is widely used. It is from the family structure or pattern that terms are allocated to relatives and real names are hardly used. Genealogy is all that matters, not proximity; no matter how far apart relatives are, they remain kinsmen. This is confirmed further by Schapera and Comaroff (1991:37) when they state:

Tswana carry recognition of kinship much further than is common in Western European society. A man differentiates between his close relatives according to sex, relative age, and line of descent, and applies a special term to each category.

This study is going to make use of the following Setswana dictionaries to illustrate the inconsistency of the entries of kinship terms: Thanodi ya Setswana by Kgasa and Tsonope (1995), Dikišinari ya Setswana, English, Afrikaans by le Roux et al (1996), the South African Multi language Dictionary by le Roux et al (1996) and The Setswana English Dictionary by Brown (1973).

Kinship terminology is a subject which has been studied by various theorists using different approaches. It is through the use of kinship terms that children grow up to know their relatives.

CHAPTER 3

DIAGRAMS AND TABLES SHOWING MAN'S RELATIVES (A2.2)

3.1 INTRODUCTION

This chapter will address the use of kinship terms in Setswana compared with other Sotho languages, namely Northern Sotho and Southern Sotho. Diagrams and tables are used to correctly place members of a family, and to give the appropriate terms used to refer to such members. Where no single term exists, an expression is used. The relationships shown in this chapter are those of the man, the Ego, who is the centre of the analysis. All the kinship terms are given in relation to the man (Ego A2.2) and his family. For purposes of comparison, each diagram is followed by three tables for Setswana, Northern Sotho and Southern Sotho. The differences and similarities are discussed following the third table. The fourth table contains dictionary entries for the Setswana kinship terms, with an evaluation of the quality of the entries. The diagrams are those employed by Van Wyk and Prinsloo (1992). The tables are divided into three columns: the first one is for the generation, the second for kinship terms from the Ego's perspective, and the third column shows kinship terms from the perspective of the Ego's wife. Notes are given at the bottom of each table for further interpretation of both the diagrams and the tables.

3.2 MAN'S GRANDPARENTS ON HIS FATHER'S SIDE

The diagram below shows the relationship between the man, Ego A2.2 (and his wife, r2.2), his parents, his grandparents, and his great grandparents. His maternal great-grandparents are also shown.

Diagram 1

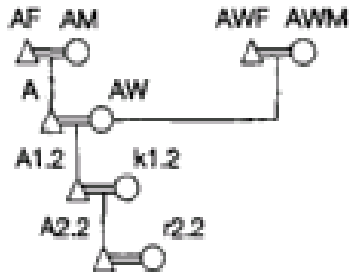

Table 1a

Relations systems of **Setswana** speakers: A-line: Parental generation (Man's Grand parents on the father's side)

Forms of address/variables (Referral terms between brackets)

F2-generation*	Ego A2.2 (Male)	Ego r2.2 (female)
Older generation		
Great grandfathers	AF**Rremogolo/Ntatemogologolwane/Rremogologolwane (mmelega rremogolo)	
	AWF Rremogolo/Ntatemogologolwane/Rremogologolwane (mmelega mmemogolo)	As by Ego (A2.2) with addition of 'wa mogatsake' (of my husband)
Great grandmothers	AM Mmemogolo/Nkoko/Mmemogologolwane (mmelega rremogolo)	

	AWM Mmemogolo/Nkoko/Mmemogolo- golwane (mmelega mmemogolo)	
Grandfather	A Ntatemogolo/Rremogolo (mmelega ntate)	
Grandmother	AW Mmemogolo/Nkuku (mmelega ntate)	

The table above shows that in Setswana, there is no difference between addressing great-grandparents and grandparents. A2.2 refers to both AF and A as ‘Borremogolo’ (grandfathers) and both AM and AWM as ‘Bommemogolo’ (grandmothers). Sometimes ‘Rremogologolwane/Ntatemogologolwane’ (great grandfather) and ‘Mmemogologolwane’ (great grandmother) are used. But this is not common in Botswana. The same applies for Ego r2.2 (female) with optional addition of ‘wa mogatsake’ meaning ‘of my husband’. Alternative to ‘wa mogatsake’, ‘wa monna wa me’ can also be used. This addition is used only in third person descriptions, not when talking to the relative concerned.

Table 1b

Relations systems of **Northern Sotho** speakers: A-line: Parental generation (Husband’s Grandparents on the father’s side)

Forms of address/variables (Referral terms between brackets)

F2-Generation*	Ego A2.2 (Male)	Ego r2.2 (female)
----------------	-----------------	-------------------

Older generation		
Great grandfathers	AF** Rakgolokhukhu /Mmelega rakgolo	As by A2.2 with optional addition of ‘wa mogatšaka’ (of my husband)
	AWF Rakgolokhukhu/Mmelega mmamogolo (koko)	
Great grandmothers	AM Mmakgolokhukhu/Mmelega rakgolo	
	AWM Mmakgolokhukhu/Mmelega mmamogolo/Mmelega koko	
Grandfather	A Rakgolo/Tatemogolo/Mmelega tate	
Grandmother	AW Mmakgolo/Koko/Mmelega tate	

(from Van Wyk and Prinsloo, 1992: 47)

The Northern Sotho has got ‘Rakgolokhukhu’ (great-grandfather) and ‘Mmakgolokhukhu’ (great-grandmother), a feature which is not present in Setswana. The wife (Ego r2.2) addresses all her husband’s parents as he does, with the optional addition of ‘wa mogatšaka’ (of my husband). The alternative to ‘wa mogatšaka’, ‘wa monnaka’ can be used.

Table 1c

Relations systems of **Southern Sotho** speakers: A-line: Parental generation
 (Husband’s grand parents on the father’s side)
 Forms of address/variables (Referral terms between brackets)

F2-generation*	Ego A2.2 (Male)	Ego r2.2 (female)
Older generation		
Great grandfathers	AF** Ntatemoholo (ntate oa ntatemoholo)	As by A2.2 with optional addition of 'oa monna oa ka' (of my husband)
	AWF Ntatemoholo (ntate oa nkhono)	
Great grandmothers	AM Nkhono (mme oa ntatemoholo)	
	AWM Nkhono (mme oa nkhono)	
Grandfather	A Ntatemoholo	
Grandmother	AW Nkhono	

Southern Sotho predominantly uses the suffix ‘-holo’ instead of ‘-golo’

Differences and similarities

When referring to great-grandparents, Northern Sotho uses 'Rakgolokhukhu' (great-grandfather) and 'Mmakgolokhukhu' (great-grandmother), terms which are not found in Setswana and Southern Sotho. Generally, the relations patterns of the three Sotho languages are the same as depicted in Diagram 1.

Table 1d

The table below shows the kinship terms used in Table 1a, their entries in four Setswana dictionaries namely the South African Multi-language Dictionary, Setswana English Dictionary, Dikišinari ya Setswana, English Afrikaans and Thanodi ya Setswana.

Term	South African Multi-language Dictionary	Setswana English Dictionary	Dikišinari ya Setswana English Afrikaans	Thanodi ya Setswana
Mmemogolo	Grandmother	No entry	Grandmother; mother's elder sister	Mmaagwe mme; nkoko; mogolo'a mme
Rremogolo	Grandfather	Grandfather; uncle	Grandfather; father's elder brother	Rraagwe ntate

Nkoko	No entry	No entry	Grandmother	Nkuku; mmaagwe mme kana ntate
Ntatemogolo	Grandfather	No entry	Grandfather; father's elder brother	Rraagwe ntate

There are no dictionary entries for Setswana expressions like 'Mmelega rremogolo' (the one who gave birth to grandfather) or 'Mmelega nkoko' (the one who gave birth to grandmother). The term 'Mmemogolo' (grandmother) in Table 1a, is used to refer to two different people in two generations. Firstly, it is used to refer to great-grandmother, secondly to refer to grandmother, both maternal and paternal. This applies to 'Rremogolo' (grandfather) too. In some contexts these terms are used to refer to mother's elder sister and father's elder brother. The table also shows that about eighty percent (80%) of the dictionaries provide entries for the terms. In some dictionaries the term 'Mmemogolo' (grandmother) has more than one meaning, that of grandmother as well as mother's elder sister. The same applies to 'Rremogolo' (grandfather), which can also refer to father's elder brother. None of the dictionaries has indicated that these two terms can be extended to the spouses, 'Mmemogolo' referring to the wife of father's elder brother, and 'Rremogolo' referring to the husband of mother's elder sister.

3.3 MAN'S FATHER'S BROTHERS AND SISTERS

The relationship shown in the diagram below is between the man (Ego A2.2) and his father's brothers and sisters, that is, his uncles and aunts on his father's side.

Diagram 2

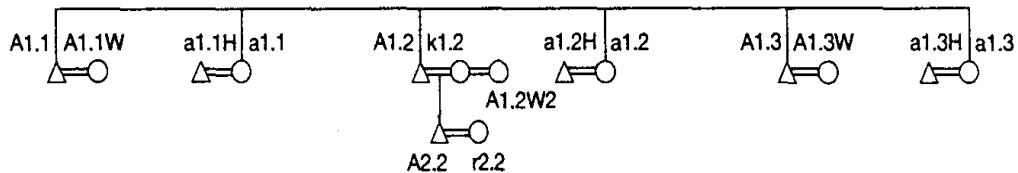

Table 2a

Relation system of **Setswana** speakers: A-line: First filial generation (Man's father's brothers and sisters)

Forms of address/variables (Referral terms between brackets)

F2-generation *	Ego A2.2 (male)	Ego r2.2 (female)
Uncle	A1.1** Rremogolo (mogolowe ntate/mogolowe rre)	As by Ego A2.2 with optional addition of 'wa mogatsake' (of my husband)
Aunt	A1.1W Mmemogolo (mogatsa rremogolo)	
Aunt	a1.1 Rakgadi (yo mogolo)	
Uncle	a1.1H Mogatsa rakgadi/Rakgadi wa monna	
Father	A1.2 Ntate/Rre/Rara	Ntate/Ratsale
Mother	k1.2 Mme/Mma	Mme/Matsale

Father's second wife	A1.2W2 Mmane/Mmangwane	Mogatsa ratsale wa bobedi
Uncle	A1.3 Rangwane	Rangwane
Aunt	A1.3W Mmangwane (mogatsa rangwane)	As by A2.2
Aunt	A1.2 Rakgadi	
Uncle	a1.2H Mogatsa rakgadi/Rakgadi wa monna	
Aunt	a1.3 Rakgadi (yo monnye)	
Uncle	a1.3H Mogatsa rakgadi	

In Setswana, any of the father's sisters are referred to as 'Rakgadi' (aunt). The inscription 'yo mogolo' (older) or 'yo monnye' (younger) normally features when talking about the aunt. The main differences between terms used by the woman and those used by her husband will be marked by 'wa mogatsake' (of my husband). The terms 'Ntate', 'Rre' and 'Rara' (father) are acceptable synonyms although 'Ntate' seems to carry more weight because it was used in early orthographies including the Bible.

Table 2b

Relations systems of **Northern Sotho** speakers: A-line: First filial generation

(Husband's father's brothers and sisters)

Forms of address/variables (Referral terms between brackets)

F2-Generation	Ego A2.2 (male)	Ego r2.2 (female)
Uncle	A1.1**Ramogolo	
Aunt	a1.1W Mmamogolo/Mogatša ramogolo	As by A2.2

Aunt	a1.1 Rakgadi (yo mogolo)	
Uncle	a1.1H Rakgadi/Mogatša rakgadi	
Father	A1.2 Tate	Ratswale/Rra
Mother	k1.2 Mma	Mmatswale/Mma
Father's second wife	A1.2W2 Mmane/Mmangwane (Mogatša tate wa bobedi)	As by A2.2 with optional addition of 'wa mogatšake' (of my husband)
Aunt	A1.2 Rakgadi	
Uncle	Aa1.2H Mogatša rakgadi	
Uncle	A1.3 Rangwane (yo monyane)	
Aunt	A1.3W Mmangwane/Mogatša rangwane	
Aunt	a1.3 Rakgadi (yo monyane)	
Uncle	a1.3H Mogatša rakgadi	

(from Van Wyk and Prinsloo, 1992: 47)

The main differences between the terms used by the woman and those used by her husband will be marked by 'wa mogatšake' (of my husband).

Table 2c

Relation system of **Southern Sotho** speakers: A-line: First filial generation
(Husband's father 's brothers and sisters)

Forms of address/variables (Referral terms between brackets)

F2-generation *	Ego A2.2 (male)	Ego r2.2 (female)
Uncle	A1.1** Ntatemoholo	As by A2.2
Aunt	A1.1W Nkhono	
Aunt	a1.1 Rakgadi	

Uncle	a1.1H Rakgadi	
Father	A1.2 Ntate	Ntate/Matsale
Mother	k1.2 Mme	Mme/Matsale
Father's second wife	A1.2W2 Mmangwane/Moqekwa	
Uncle	a1.3 Rangwane	
Aunt	A1.3W Mosadi oa rangwane	As by A2.2
Aunt	a1.2 Rakgadi	
Uncle	a1.2H Monna oa rakgadi	
Aunt	a1.3 Rakgadi	
Uncle	a1.3H Monna oa rakgadi	

The kinship pattern for Southern Sotho is similar to that of Setswana, except for some spelling differences where the former predominantly uses 'h' in cases where the latter uses 'g'. The other marked difference between Southern Sotho and the other Sotho languages is the absence of the term 'Mogatsa' (Setswana), or 'Mogatša' (Northern Sotho) which means spouse. Southern Sotho specifies spouse as 'Monna oa' or 'Mosadi oa'.

Table 2d

The following table contains dictionary entries for the kinship terms found in table 2a

Term	South African Multi-language Dictionary	Setswana English Dictionary	Dikišinari ya Setswana English Afrikaans	Thanodi ya Setswana
Rremogolo	No entry	No entry	Father's elder brother	Monna yo mogolo mo go Ntate
Ntate/Rre/Rara	Father(n)	No entry	Father	Rre; monna yo ntsetseng
Rakgadi	No entry	No entry	Father's sister or her husband	Kgaityadi'a ntate
Mme	Mother	No entry	My mother	Motsadi wa me wa mosadi
Rangwane	No entry	No entry	Father's younger brother	Monnawe ntate

The terms 'Ntate', 'Rre' and 'Rara' (father) as they appear in the table above, are all acceptable synonyms. As such, some Setswana dictionaries would have an entry for any of them. When taking the entries from the dictionaries, the researcher has taken context into consideration, hence a term like 'Rremogolo' (grandfather) does not have an entry in The South African Multi-language Dictionary (1996) because here it is used to refer to father's elder brother. About forty-five percent (45%) of the terms in the above table have not been treated in the Setswana dictionaries.

3.4 RELATIONSHIP BETWEEN TWO (2) FAMILY GENERATIONS

In the diagram and table to follow, two family generations are shown, parents and their sons and daughters. The relationship shown is between the man (Ego A2.2) and his own brothers and sisters. The dominant terms in this relationship are ‘Nkgonne or mogolole’ (elder brother), ‘Kgaityadi’ (sister or brother) and ‘Nnake’ (younger brother or sister).

Diagram 3

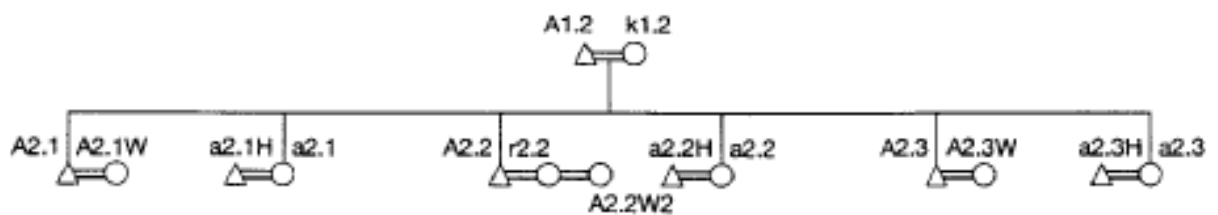

Table 3a

Relations system of **Setswana** speakers: A-line: Second filial generation (Man’s own brothers and sisters)

Forms of address/variables (Referral terms between brackets)

F2-generation *	Ego A2.2 (male)	Ego r2.2 (female)
Older Generation	A2.1**	
Eldest brother	Mogolole/Nkgonne/Morwarre	
Eldest brother’s wife	A2.1W Mogatsa nkgonne	
Oldest sister	a2.1 Kgaityadiake/Kgaityedi/Mogolole	Mogadibo
Eldest sister’s husband	a2.1H Mogatsa kgaityadiake	
Ego	A2.2 ... Nna	Mogatsake
Wife	r2.2 Mogatsaka/mogatsake	
Second wife	A2.2W2 Mogatsake wa bobedi	Mmane/ Mogadikane

Youngest brother	A2.3 Nnake/Mmotlana	Nnake
His wife	A2.3W Mogatsa nnake	
Young sister	a2.2 Kgaitšadi/Nnake	Mogadibo
Her husband	a2.2H Mogatsa kgaitšadiake	
Youngest sister	a2.3 Kgaitšadiake/Nnake	Mogadibo
Her husband	a2.3H Mogatsa kgaitšedi	

The term 'Morwarre' (brother) is currently used for a broader purpose than only referring to one's brother. It is sometimes used in informal situations to refer to a colleague. The Ego's wife uses the term 'Mogadibo' (sister-in-law) to refer to her husband's sisters.

Table 3b

Relations systems of **Northern Sotho** speakers: A-line: Second filial generation
(Man's own brothers and sisters).

Forms of address/variables (Referral terms between brackets)

F2-generation*	Ego A2.2 (male)	Ego r2.2 (female)
<u>Older generation</u>		
Eldest brother	A2.1**Mogolle/Mogolwake	Ramogolo/Mogolle
His wife	A2.1W Mogatša mogolle/ Mogatša mogolwake	Same as for A2.2
Eldest sister	a2.1 Kgaitšedi/Mogolwake (yo mogolo)	Mogadibo/Mogolle
Her husband	a2.1H Molamo/Mogatša kgaitšedi (yo mogolo)	Mogatša mogadibo
Ego	A2.2 --- Nna	Mogatšaka/Mogatšake
Wife	r2.2 Mogatšake/Mogatšaka	--- Nna

Second wife	A2.2w2 Mogatšake (wa bobedi)	Mmane/Mogadikana
Youngest brother	A2.3 Samma/Moratho/Nnake/Ngwanego	Rangwane/Moratho
His wife	A2.3W Mogatša moratho/Mogatša nnake	
Young sister	a2.2 Kgaitšedi/Moratho/Monyanana	Mogadibo
Her husband	a2.2H Molamo	Mogatša mogadibo
Youngest sister	a2.3 Same as for a2.2	As for a2.2
Her husband	a2.3H Same as for a2.2	As for a2.2

(from Van Wyk and Prinsloo,

1992:48)

The table above contains a number of kinship terms that are only used in Northern Sotho.

Table 3c

Relations system of **Southern Sotho** speakers: A-line: Second filial generation

(Man's own brothers and sisters)

Forms of address/variables (Referral terms between brackets)

F2-generation *	Ego A2.2 (male)	Ego r2.2 (female)
Older Generation		
Eldest brother	A2.1** Moholwane	
His wife	A2.1W Mosadi oa moholwane	
Oldest sister	a2.1 Kgaitšedi	
Her husband	a2.1H Monna oa kgaitšedi	

Ego	A2.2 ...Nna	Mogatsaka
Wife	r2.2 Mogatsaka	
Second wife	A2.2W2 Mosadi oa ka oa bobedi/Moqekwa	As by A2.2
Youngest brother	A2.2 Samme/Monyanana/Monyane/Moena	
His wife	A2.3W Mosadi oa monyane	
Younger sister	a2.2 Kgaitsemi	
Her husband	a2.2H Monna oa kgaitsemi	
Youngest sister	a2.3 Kgaitsemi	
Her husband	a2.3H Monna oa kgaitsemi	

The table above contains certain kinship terms and expressions that are only applicable in Southern Sotho.

Differences and Similarities

There are a number of differences in kinship terms as depicted by the three tables above. For instance, in Setswana a man can refer to his brother as 'Morwarre', but the Northern Sotho has 'Moratho' or 'Samma', while Southern Sotho uses 'Moena'. There is also the term 'Molamo' (sister-in-law) which is not found in Setswana.

Table 3d

In the table below we find kinship terms used in Table 3a and their entries in some Setswana dictionaries.

Term	South African Multi-language Dictionary	Setswana English Dictionary	Dikišinari ya Setswana English Afrikaans	Thanodi ya Setswana
Nkgonne	No entry	No entry	Elder brother or sister	Mosimane yo motona mo lwapeng a tewa ke monnawe wa mosimane
Mogatsa nkgonne	No entry	No entry	No entry	No entry
Kgaityadi	Sister	Kgantsadi; a man's sister; a woman's brother	My sister (used by her brother); my brother (used by his sister)	Bolosika jwa mosetsana le mosimane ba e leng bana ba motho
Mogatsa kgaityadiake	Sister-in-law	No entry	My husband's sister; my brother's wife	Motho yo o nyetsweng ke kgaityadiake; kgaityadi wa monna wa me
Mogatsake wa bobedi	No entry	No entry	No entry	No entry
Nnake	No entry	No entry	My younger brother or sister	Ngwana wa batsadi ba me yo o tsetsweng fa morago ga me
Mogatsa nnake	No entry	No entry	No entry	No entry

Several kinship terms in the table above do not have entries in dictionaries because in Setswana, where such terms do not exist, a phrase is used. Usually the phrase clearly defines the relationship between the speaker and the person referred to. For example, the phrase 'Mogatsa nnake' (brother-in-law or sister-in-law) conveys meaning for as long as the gender of the speaker is known. There is no entry in any of the dictionaries used for 'Mogatsake wa bobedi' (father's second wife) because polygamy is not formal in Setswana culture. Traditionally, it used to be accepted, hence the sons and daughters of the first wife refer to the second wife as 'Mmane or Mmangwane' (aunt),

and those of the second wife refer to the first wife as 'Mmemogolo'. The treatment of kinship terms in the table above is satisfactory; the only problem is that most relationships shown are expressed in phrases and not single words. Fifty percent (50%) of the terms have been treated in dictionaries.

3.5 RELATIONSHIP BETWEEN TWO (2) GENERATIONS, MAN'S FATHER'S BROTHERS AND SISTERS, WITH THEIR CHILDREN

We find in this diagram and table two family generations, the man's father's brothers and sisters, as well as their children who are the Ego (A2.2)'s cousins from his father's side. There is a recurrent use of the terms 'Mogolole/Nkgonne' (elder brother or sister), 'Nnake' (younger brother or sister) and 'Kgaitisadi' (sister). These terms are used here to refer to relations that in English would be called cousins. This is so because in Setswana a child is supposed to treat children of his/her parents' brothers and sisters as though they are his own brothers and sisters. The bond is quite strong.

Diagram 4

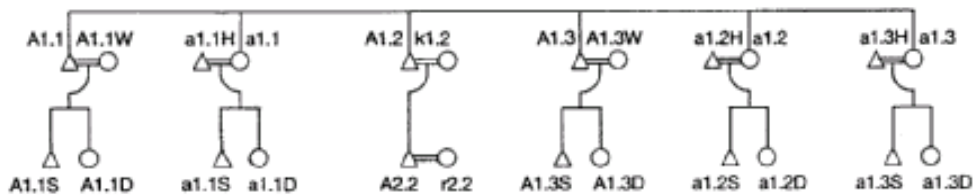

Table 4a

Relations systems of **Setswana** speakers: A-line: Second filial generation (Children of man's father's brothers and sisters)

Forms of address/variables (Referral terms between brackets)

F2-generation*	Ego A2.2 (male)	Ego r2.2 (female)
Older generation		
Cousin	A1.1S**Morwarre/Mogolole (morwa wa rremogolo)	Nnake (morwa wa rremogolo wa mogatsake)
Cousin	A1.1D Kgaitisadi (morwadi a rremogolo)	Mogadibo

Cousin	a1.1S Ntsalake (morwa wa rakgadi)	Ntsalake
Cousin	a1.1D Ntsala (morwadi wa rakgadi)	
Younger generation		
Cousin	A1.3S Morwarre/Mogolole/Nkgonne/ Nnake (morwa wa ga rangwane)	As by a1.1D
Cousin	A1.3D Kgaitsadi (morwadi-a-rangwane)	
Cousin	a1.2S As for a1.1S with (yo mogolo) Also replaced by (yo monnye)	
Cousin	a1.2D As for a1.1D with (yo mogolo) Also replaced by (yo monnye)	
Coussin	a1.3S As for a1.1S with (yo mogolo)	
Cousin	a1.3D As for a1.1D with (yo mogolo)	

Where specific gender indication is not relevant, ‘Morwa’ (son) or ‘Morwadi’ (daughter) can be replaced by ‘Ngwana’ (child).

Table 4b

Relations systems of **Northern Sotho** speakers: A-line: Second filial generation
(Man’s father’s brothers and sisters’ children)

Forms of address/variables (Referral terms between brackets)

F2-generation*	Ego A2.2 (male)	Ego r2.2 (female)
Older generation		
Cousin	A1.1S**Morwarre/Mogolwake/ Moratho/Morwa wa ramogolo	Morwa wa ramogolo wa mogatšake
Cousin	A1.1D Kgaitšedi/Mogolwake/ Monyanana/Morwedi wa ramogolo	Mogadibo
Cousin	a1.1S Motswala/Morwa wa rakgadi	
Cousin	a1.1D Motswala/Morwedi wa rakgadi	
Younger generation		
Cousin	A1.3S Morwarre/Mogolwake/ Moratho/Morwa wa rangwane	
Cousin	A1.3D Mogolwake/Kgaitšedi/Moratho/ Monyanana/Morwedi wa rangwane	Mogadibo/Morwedi wa rangwane wa mogatšaka
Cousin	a1.2S Same as for a1.1S with (yo mogolo) or (yo monyane)	As by a1.1S
Cousin	a1.2D Same as a1.1D with (yo mogolo) or (yo monyane)	
Cousin	a1.3S As for a1.1S with (yo mogolo)	
Cousin	a1.3D As for a1.1D with (yo mogolo)	

(from Van Wyk and Prinsloo, 1992:49)

The kinship pattern for Northern Sotho is just the same as that of Setswana in the above table, except for some minor spelling differences, for example, ‘Morwadi’ (daughter) in Setswana is ‘Morwedi’ (daughter) in Northern Sotho.

Table 4c

Relations systems of **Southern Sotho** speakers: A-line: Second filial generation
(Children of man’s father’s brothers and sisters)

Forms of address/variables (Referral terms between brackets)

F2-generation*	EgoA2.2 (male)	Ego r2.2 (female)
Older generation		
Cousin	A1.1S**Moholwane (mora oa ntatemoholo)	Mora oa ntatemoholo oa monna a ka (of my husband)
Cousin	A1.1D Kgaitsemi (moradi a ntatemoholo)	
Cousin	a1.1S Motswala (mora oa rakgadi)	Motswala
Cousin	a1.1D Ngwana-rakgadi	As by a1.1D
Younger generation		
Cousin	A1.3S Moholwane (ngwana oa rangwane)	
Cousin	A1.3D Kgaitsemi (ngwana oa rangwane)	
Cousin	a1.2S As for a1.1S with (ya moholo). Also replaced by (ya monnyane)	

Cousin	a1.2D As for a1.1D with (ya moholo). Also replaced by (ya monnyane)	
Cousin	a1.3S As for a1.1S with (ya moholo)	As for a1.1S
Cousin	a1.3D As for a1.1D with (ya moholo)	As for a1.1D

The table above indicates that the kinship pattern for Southern Sotho is the same as that of Setswana.

Differences and similarities

The difference in spelling for ‘Morwa’ (son) and ‘Morwadi’ (daughter) in Setswana and ‘Mora’ (son) and ‘Moradi’ (daughter) in Southern Sotho is noted in Table 4c. Also, Setswana does not have the terms ‘Moratho’ or ‘Monyanana’ (younger brother) as well as ‘Motswala’ (cousin), which are used in Northern Sotho. The Setswana terms are ‘Nnake’ (younger brother or sister) and ‘Ntsala (ka)’ (cousin). ‘Motswala’ (cousin) is used in Southern Sotho too. There is also the use of the term ‘Morwarre’ in Setswana and Northern Sotho uses as a synonym for ‘Mogolole’ or ‘Nkgonne’ (elder brother).

Table 4d

The table below contains dictionary entries for the Setswana kinship terms found in Table 4a, the purpose being to enable the researcher to evaluate the treatment of these terms.

Term	South African Multi-language Dictionary	Setswana English Dictionary	Dikišinari ya Setswana English Afrikaans	Thanodi ya Setswana
Morwarre/Mogolole/Nkgonne	No entry	No entry	Elder brother or sister	Mosimane yo motona mo lwapeng, a tewa ke monnawe wa mosimane
Nnake	No entry	No entry	My younger brother or sister	Ngwana wa batsadi ba me yo o tsetsweng fa morago ga me
Kgaitsemi	Sister	Kgantsadi; a man's sister; A woman's brother	My sister (used by her brother)	Bolosika jwa mosetsana le mosimane ba e leng bana ba motho
Ntsalake	Nephew or niece	No entry	Mother's brother's child; father's sister's child	Ngwana wa ga malome kana rakgadi

The terms 'Mogolole' (elder brother), 'Nnake' (younger brother or sister), and 'Kgaitsemi' (sister or brother) are used and defined only to refer to one's own brother or sister, that is, children of the same parents. In Table 4a, these terms are used to refer to the man's cousins. The term 'Ntsalake' (cousin) is the one that is entered appropriately. The treatment of these terms in the Setswana dictionaries referred to is about eighty-five percent (85%), except that context was not taken into consideration.

3.6 RELATIONSHIP BETWEEN MAN’S OWN CHILDREN’S PARENTS-IN-LAW

The relationship shown below is between the man (Ego A2.2) and his children’s parents-in-law. He refers to them as either ‘Mogwe’ or ‘Mogwegadi’ (in-laws) depending on the gender of his own children. For his sons, their parents-in-law are the Ego’s ‘Bagwegadi’, and he refers to his daughters’ in-laws as ‘Bagwe’.

Diagram 5

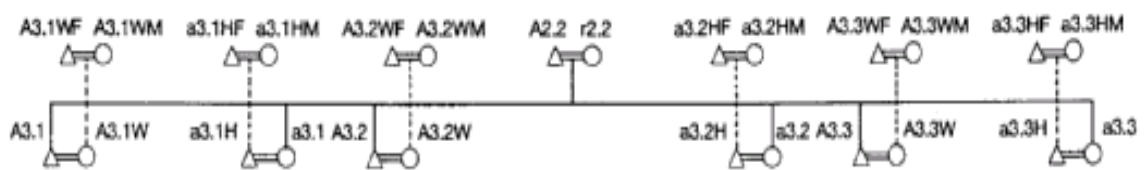

Table 5a

Relations systems of **Setswana** speakers: A-line (Man’s own children’s parents-in-law)

Forms of address/variables (Referral terms between brackets)

F2-generation*	Ego A2.2 (Male)	Ego r2.2 (female)
	A3.1WF** Mogwegadi (wa ka) ka morwa yo mogolo)	As by Ego A2.2
	A3.1WM Mogwegadi	
	a3.1HF Mogwe (wa ka) ka morwadiake yo mogolo)	
	a3.1HM Mogatse mogwe (ka morwadiake yo mogolo)	As by Ego A2.2
	A3.2WF Mogwegadi (wa ka) ka morwa wa bobedi	
	A3.2WM Mogwegadi	As by Ego A2.2

	a3.2HF Mogwe (wa ka) ka morwadiake wa bobedi	
	a3.2HM Mogatsa mogwe	
	A3.3WF Mogwegadi (wa ka) ka morwa wa gofejane	
	A3.3WM Mogwegadi	

In the table above the term ‘Mogwegadi’ is used to refer to both sets of parents-in-law, male or female, although the suffix ‘ –gadi’ is normally associated with the feminine.

Table 5b

Relations systems of **Northern Sotho** speakers: A-line: (Man’s own children’s parents in-law)

Forms of address/variables (Referral terms between brackets)

F2-generation*	Ego A2.2 (male)	Ego r2.2 (female)
	A3.1WF**Mokgotse (ka morwa yo mogolo)	
	A3.1WM Mokgotse wa mosadi	
	a3.1HF Mokgotse (ka morwedi yo mogolo)	
	a3.1HM Mogatša mokgotse	
	A3.2WF Mokgotse (ka morwa wa bobedi)	As by Ego A2.2

	A3.2WM Mogatša mokgotse	As by A2.2
	a3.2HF Mokgotse (ka morwedi wa bobedi)	
	a3.2HM Mogatša mokgotse	
	A3.3WF Mokgotse (ka morwa wa phejane)	
	A3.3WM Mogatša mokgotse	

(from Van Wyk and Prinsloo,

1992:50)

This table shows the Northern Sotho term ‘Mokgotse’ (son or daughter’s parent-in-law) which is not found in Setswana.

Table 5c

Relations systems of **Southern Sotho** speakers: A-line (Man’s own children’s parents-in-law)

Forms of address/variables (Referral terms between brackets)

F2 generation*	Ego A2.2 (Male)	Ego r2.2 (female)
	A3.1WF** Mohwehadi/Mokgotse (oa ka ka mora ya moholo)	As by Ego A2.2
	A3.1WM Mohwehadi/Mokgotse oa mosadi	

	a3.1HF Mohwe/Molamo/Mokgotse (oa ka) ka moradi oa ka ya moholo)	
	a3.1HM Mokgotse oa mosadi	
	A3.2WF Mohwehadi (oa ka) ka mora oa bobedi	
	A3.2WM Mohwehadi	As by A2.2
	a3.2HF Molamo (oa ka) ka moradi oa ka oa bobedi	
	a3.2HM Molamo oa mosadi	
	A3.3WF Mohwehadi (oa ka) ka mora oa kgorula	
	A3.3WM Mohwehadi	

The table above contains the expression ‘oa kgorula’ (last born), which is not found in the other two languages.

Differences and similarities

Setswana, unlike its Sotho counterparts uses the terms ‘Mogwe’ and ‘Mogwegadi’ to refer to the man’s children’s parents-in-law, for his sons as well as for his daughters. On the other hand, Northern Sotho and Southern Sotho have the terms ‘Mokgotse’ and ‘Molamo’ for these in-laws.

Table 5d

The following table contains dictionary entries for the Setswana kinship terms found in Table 5a

Term	South African Multi- language Dictionary	Setswana English Dictionary	Dikišinari ya Setswana English Afrikaans	Thanodi ya Setswana
Mogwegadi	Mother-in-law	No entry	No entry	Motsadi wa mosadi yo o nyetsweng a tewa ke monna wa ngwana wa gagwe
Mogwe	Son-in-law	No entry	No entry	Monna yo o nyetseng, a tewa ke batsadi ba mosadi wa gagwe

The dictionary entries for in-laws are broadly used in Setswana to cover not only the son-in-law or the daughter-in-law, but also their parents. For instance, ‘Mogwegadi’ is a term that is used by a man’s parents referring to his wife’s parents, while ‘Mogwe’ is a term used by a woman’s parents referring to her husband’s parents. The dictionary entries here do not address the parents, which gives an unsatisfactory treatment of these kinship terms.

3.7 MAN’S OWN CHILDREN AND THEIR HUSBANDS AND WIVES

The relation shown here is between the man and his sons and daughters-in-law. The most dominating terms used in this table are ‘Morwake’ (my son), ‘Ngwetsi’ (his wife or daughter-in-law), ‘Morwadiake’ (my daughter) and ‘Mogwe’ (her husband or son-in-law). This relation is the same for the Ego’s wife (r2.2).

Diagram 6



Table 6a

Relations systems of **Setswana** speakers: A-line: Third filial generation (Man’s own children and their husbands or wives)

Forms of address/variables (Referral terms between brackets)

F2-generation*	Ego A2.2 (male)	Ego r2.2 (female)
Sons	A3.1** Morwake (yo mogolo)	As by A2.2
	A3.1W Ngwetsi (e kgolo)	
	A3.2 Morwake (wa bobedi)	
	A3.2W Ngwetsi (ya ka ya bobedi)	
	A3.3 Morwake (wa gofejane)	
	A3.3W Ngwetsi (ya gofejane)	

Daughters	A3.1 Morwadiake (yo mogolo)	As by Ego A2.2
	A3.1H Mogwe (yo mogolo)	
	A3.2 Morwadiake (wa bobedi)	
	A3.2H Mogwe (wa bobedi)	
	A3.3 Morwadiake (wa bofelo)	

The terms 'Mogwe' (son-in-law) and 'Ngwetsi' (daughter-in-law) are used appropriately in the table above.

Table 6b

Relations systems of **Northern Sotho** speakers: A-line: Third filial generation (Man's own children and their families).

Forms of address/variables (Referral terms between brackets)

F2-generation*	Ego A2.2 (male)	Ego r2.2 (female)
Sons	A3.1**Morwake (yo mogolo)	As by A2.2
	A3.1W Ngwetši (ya ka ya pele)	
	A3.2 Morwake (wa bobedi)	
	A3.2W Ngwetši (ya bobedi)	
	A3.3 Morwake (wa phejane/wa mafelelo)	

	A3.3W Ngwetši (ya ka ye nyane)	As by A2.2
Daughters	a3.1 Morwediate (wa ka wa leitšibolo)	
	a3.1H Mokgonyana (wa ka yo mogolo)	
	a3.2 Morwediate (wa bobedi)	
	a3.2H Mokgonyana (wa bobedi)	
	a3.3 Morwediate (wa mafelelo/wa phejane/ yo monyane)	
	a3.3H Mokgonyana (wa mafelelo)	

(from Van Wyk and Prinsloo, 1992:

50)

The pattern of kinship terms in the table above is the same as that of Setswana, except the differences in the spelling of 'leitšibolo' – the diacritic 'š' is not used in Setswana, it is just 'leitibolo' (first born). There is also 'ngwetši' with a diacritic 'š' which in Setswana is 'ngwetsi' (daughter- in- law). Again, Northern Sotho has 'phejane' which in Setswana is 'gofejane' (last born).

Table 6c

Relations systems of **Southern Sotho** speakers: A-line: Third filial generation

(Husband's own children and their husbands/wives)

Forms of address/variables (Referral terms between brackets)

F2-generation*	Ego A2.2 (male)	Ego r2.2 (female)
Sons	A3.1** Mora oa ka (ya moholo)	As by A2.2
	A3.1W Ngwetsi (e kholo)	
	A3.2 Mora oa ka (oa bobedi)	
	A3.2W Ngwetsi (ya ka ya bobedi)	
	A3.3 Mora oa ka (oa kgorula)	
	A3.3W Ngwetsi (ya kgorula)	
Daughters	A3.1 Moradiake (ya moholo)	As by Ego A2.2
	A3.1H Mohwe/Mokhoenyana (ya moholo)	
	A3.2 Moradiake (oa bobedi)	
	A3.2H Mohwe/Mokhoenyana (oa bobedi)	
	A3.3 Moradiake (oa kgorula)	

The term 'Mokhoenyana' (son-in-law) is used in Southern Sotho as a synonym for 'Mohwe'.

Differences and similarities

Although all the three Sotho languages use the term 'Mogwe' (son-in-law), Northern Sotho and Southern Sotho also have 'Mokgonyana or Mokhoenyana', which is not found in Setswana. The expression for 'last born' in Southern Sotho is 'wa kgorula' while in Setswana it is 'wa bofelo' (last one) and Northern Sotho has 'wa phejane'. Setswana also has a single term 'gofejane' (last born).

Table 6d

The following table contains dictionary entries for the kinship terms found in table 6a above

Term	South African Multi- language Dictionary	Setswana English Dictionary	Dikišinari ya Setswana English Afrikaans	Thanodi ya Setswana
Morwa	Son	No entry	Son; Mmotlana	Ngwana wa motho wa mosimane
Ngwetsi	Daughter-in- law	No entry	Daughter-in- law	Mosadi yo o nyetsweng a bidiwa ke bo- matsalaagwe
Morwadi	Daughter	Morwadi; daughter	Daughter	Ngwana wa motho wa mosetsana
Mogwe	Son-in-law	No entry	Son-in-law	Monna yo o nyetseng a tewa ke batsadi ba mosadi wa gagwe

These four terms are used to refer to all of the man's sons and daughters, as well as their spouses, and have been entered as such in the Setswana dictionaries. They are differentiated by the addition of 'yo mogolo' (older one) or 'yo monnye' or 'wa bofelo' (younger one or last one). The dictionary entries are precise and there is no ambiguity. The treatment of the terms here is about ninety-five percent (95%).

3.8 MAN’S BROTHERS’ AND SISTERS’ CHILDREN

The diagram and table to follow depict the man and his relationship with his nephews and nieces. The terms ‘Morwa’ (son) and ‘Morwedi’ (daughter) are used in conjunction with ‘wa mogolole’ (of my elder brother) or ‘wa nnake’ (of my younger brother). The younger brothers’ children refer to Ego A2.2 as ‘Rremogolo’, a term which is commonly used to refer to grandfather, though the literal meaning is ‘older father’. The dominant term used by the man to refer to his sisters’ children is ‘Motlogolo’ (nephew or niece). The Ego’s wife (r2.2) refers to all these children as nephews or nieces.

Diagram 7

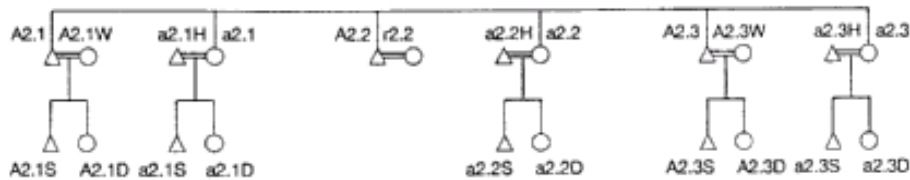

Table 7a

Relations systems of **Setswana** speakers: A-line: Third filial generation (Man’s brothers and sisters’ children).

Forms of address/variables (referral terms between brackets)

F2-generation*	Ego A2.2 (male)	Ego r2.2 (female)
Brothers’ Children	A2.1S** Morwa (wa ga mogolole)	Morwa (wa mogolo-a-mogatsake)
	A2.1D Morwadi (wa ga mogolole)	Morwadi-a-mogolo-a-mogatsake
	A2.3S Morwa (wa ga nnake)	Morwa (wa monnawe mogatsake)

	A2.3D Morwadi (wa ga nmake)	Morwadi-a-monnawe mogatsake
Sisters' Children	a2.1S Motlogolo/Setlogolo (morwa wa kgaitsadiake yo mogolo)	Motlogolo (morwa wa mogadibo yo mogolo)
	a2.1D Motlogolo/Setlogolo (morwadi wa ga kgaitsadiake yo mogolo)	Motlogolo (morwadi wa mogadibo yo mogolo)
	a2.2S Motlogolo/Setlogolo (morwa wa kgaitsadiake yo monnye/yo mmotlana)	Motlogolo (morwa wa mogadibo yo monnye)
	a2.2D Motlogolo/Setlogolo (morwadi wa ga kgaitsadiake yo mmotlana)	Motlogolo (morwadi wa mogadibo yo monnye)
	a2.3S As by a2.2S above	As by a2.2S
	a2.3D As by a2.2D above	As by a2.2D

The term 'Morwadi' (daughter) is usually used with '-a-' in Setswana. The Northern Sotho term is 'Morwedi' showing a difference in spelling. For the sisters' children, 'Motlogolo' can be replaced by 'Setlogolo' (nephew or niece) in Setswana. But 'Setlogolo' is normally used in informal situations. The formal term is 'Motlogolo'.

Table 7b

Relations systems of **Northern Sotho** speakers: A-line: Third filial generation
(Husband's brothers and sisters' children)

Forms of address/variables (Referral terms between brackets)

F2-generation*	Ego A2.2 (male)	Ego r2.2 (female)
Brothers' Children	A2.1S**Morwa (wa mogolwake)	As by A2.2, with optional addition of 'wa mogatšaka' (of my husband)
	A2.1D Morwedi (wa mogolle)	
	A2.3S Morwa (ka) (Morwa wa moratho/Samma/Nnake)	
	A2.3D Morwedi (Morwedi wa nnake/moratho/samma)	
Sisters' Children	a2.1S Motlogolo (Morwa wa kgaitšedi (yo mogolo)	Morwa wa mogadibo
	a2.1D Motlogolo (Morwedi wa kgaitšedi (yo mogolo)	Morwedi wa mogadibo
	a2.2S Motlogolo (Morwa wa kgaitšedi (yo monyane)	
	a2.2D Motlogolo (Morwedi wa kgaitšedi (yo monyane)	
	a2.3S As by a2.2S	As by A2.2
	a2.3D As by a2.2D	As by A2.2

(from Van and Wyk Prinsloo,

1992:51)

The term 'Motlogolo' (nephew or niece) can be replaced by 'Setlogolo' in Setswana to address one's sister's child.

Table 7c

Relations systems of **Southern Sotho** speakers: A-line: Third filial generation (Man's brothers and sisters' children).

Forms of address/variables (referral terms between brackets)

F2-generation*	Ego A2.2 (male)	Ego r2.2 (female)
Brothers' Children	A2.1S** Mora (oa moholwane)	As by A2.2
	A2.1D Moradi (oa moholwane)	
	A2.3S Mora (oa monyane)	
	A2.3D Moradi (wa monyane)	
Sisters' Children	a2.1S Motjhana (mora oa kgaitsedi yo moholo)	As by A2.2
	a2.1D Motjhana (moradi oa kgaitsedi ya moholo)	
	a2.2S Motlogolo (mora oa kgaitsedi ya monnyane)	
	a2.2D Motjhana (moradi oa kgaitsedi ya monnyane)	
	a2.3S As by a2.2S	As by a2.2S
	a2.3D As by a2.2D	As by a2.2D

The term 'Moradi' is spelt without 'w' in Southern Sotho which differs from the Setswana spelling of 'Morwadi', and 'Mora' (son) which is 'Morwa' in Setswana.

Differences and similarities

The term ‘Motlogolo’ (nephew or niece) is used in Setswana and Northern Sotho, but not in Southern Sotho which uses ‘Motjhana’. Basically, the pattern of kinship terms used is the same for the three Sotho languages.

Table 7d

The dictionary entries for the kinship terms found in Table 7a are presented in the following table

Term	South African Multi-language Dictionary	Setswana English Dictionary	Dikišinari ya Setswana English Afrikaans	Thanodi ya Setswana
Morwa	Son	No entry	Son; Mmotlana	Ngwana wa motho wa mosimane
Morwadi	Daughter	Morwadi; daughter	Daughter	Ngwana wa motho wa mosetsana
Motlogolo	No entry	No entry	My sister’s child (used by her brother or his wife)	Ngwana wa ngwanake; ngwana wa kgaitsadi

The terms ‘Morwa’ (son) and ‘Morwadi’ (daughter) are used in this table, but not to refer to the man’s own children. In the Setswana culture the man is supposed to treat and address his brothers’ children as his own, and they also treat him as their father, especially in the absence of their own fathers. The term ‘Motlogolo’ in this case refers to the man’s sister’s child and not grandchild as certain dictionaries show. The terms have been satisfactorily treated, about ninety-five percent (95%) of the terms have entries in the Setswana dictionaries used.

3.9 MAN’S GRANDCHILDREN

The Setswana term used by the man to refer to his grandchildren is ‘Ngwanaangwanake’. This term is used for both males and females. The Ego’s wife (r2.2) in this case also uses the term ‘Ngwanaangwanake’ (grandchild).

Diagram 8

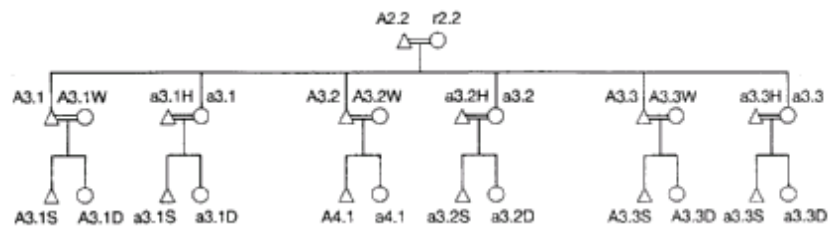

Table 8a

Relations systems of **Setswana** speakers: A-line: Forth filial generation (Man’s grand-children)

Forms of address/variables (Referral terms between brackets)

F2-generation*	EgoA2.2 (male)	Ego r2.2 (female)
Sons’ children	A3.1S**Ngwanaangwanake (morwa wa morwake yo mogolo)	Ngwanaangwanake
	A3.1D Ngwanaangwanake (morwadi-a-morwake yo mogolo)	

	A4.1 As by A3.1S (Replace 'yo mogolo' with 'wa bobedi')	As by Ego A2.2
	a4.1 As by A3.1D (Replace 'yo mogolo' with 'wa bobedi')	
	A3.3S As by A3.1S (Replace 'yo mogolo' with 'wa gofejane')	
	A3.3D As by A3.1D (Replace 'yo mogolo' with 'wa gofejane')	
Daughters' Children	a3.1S Ngwanaangwanake (morwa wa morwadiake yo mogolo)	
	a3.1D Ngwanaangwanake (morwadi-a-morwadiake yo mogolo)	
	a3.2S As by A3.1S (Replace 'yo mogolo' with 'wa bobedi')	
	a3.2D As by A3.1D (Replace 'yo mogolo' with 'wa bobedi')	
	a3.3S As by A3.1S (Replace 'yo mogolo' with 'wa gofejane')	As by A2.2
	a3.3D As by for A3.1D (Replace 'yo mogolo' with 'wa gofejane')	

The Setswana term ‘Ngwanaangwanake’ (grandchild) has no gender difference, unlike in English where there is grandson and granddaughter.

Table 8b

Relations systems of **Northern Sotho** speakers: A-line: Forth filial generation (Man’s grandchildren)

Forms of address/variables (Referral terms between brackets)

F2-generation*	Ego A2.2 (male)	Ego r2.2 (female)
Son’s children	A3.1S**Motlogolo/Motlogolwake/ Ngwanangwanake (Morwa wa morwake yo mogolo)	As by for A2.2
	A3.1D Motlogolo (Morwedi wa morwake yo mogolo)	
	A4.1 As by A3.1S (replace ‘yo mogolo’ with ‘wa bobedi’)	
	a4.1 As by A3.1D (replace ‘yo mogolo’ with ‘wa bobedi’)	
	A3.3S As by A3.1S (replace ‘yo mogolo’ with ‘wa phejane’)	
	A3.3D As by A3.1D (replace ‘yo mogolo’ with ‘wa phejane’)	
Daughters’ Children	a3.1S Motlogolo/Ngwanangwanake (Morwa wa morwedi yo mogolo)	
	a3.1D Motlogolwake (Morwedi wa morwedi yo mogolo)	
	a3.2S As by A3.1S	
	a3.2D As by 3.1D	
	a3.3S As by 3.1S	
	a3.3D As by 3.1D	

(from Van Wyk and Prinsloo, 1992:51)

The table above shows the use of the suffix ‘-ake’ to indicate the possessive, instead of using ‘wa ka’ (mine), for instance, in ‘Motlogolwake’ (my grandchild).

Table 8c

Relations systems of **Southern Sotho** speakers: A-line: Fourth filial generation
(Man’s grand-children)

Forms of address/variables (Referral terms between brackets)

F2-generation*	EgoA2.2 (male)	Ego r2.2 (female)
Sons’ children	A3.1S**Setloholo (mora wa mora oa ka ya moholo)	Setloholo
	A3.1D Setloholo (moradi oa mora oa ka ya moholo)	
	A4.1 As by for A3.1S (Replace ‘ya moholo’ with ‘oa bobedi’)	
	a4.1 As by for A3.1D (Replace ‘ya moholo’ with ‘oa bobedi’)	
	A3.3S As by for A3.1S (Replace ‘ya moholo’ with ‘oa kgorula’)	As by Ego A2.2
	A3.3D As by for A3.1D (Replace ‘ya moholo’ with ‘oa kgorula’)	
Daughters’ children	a3.1S Setloholo (mora oa moradi oa ka ya moholo)	
	a3.1D Setloholo (moradi oa moradi oa ka ya moholo)	As by A2.2

	a3.2S As by A3.1S (Replace 'ya moholo' with 'oa bobedi')	
	a3.2D As by A3.1D (Replace 'ya moholo' with 'oa bobedi')	
	a3.3S As by A3.1S (Replace 'ya moholo' with 'oa kgorula')	
	a3.3D As by for A3.1D (Replace 'ya moholo' with 'oa kgorula')	

The table above shows that the term used for grandchild, 'Setloholo', has no gender difference.

Differences and similarities

Setswana and Northern Sotho use the terms 'Ngwanaangwanake' and 'Ngwanangwanaka' respectively to refer to grandchild, while Southern Sotho uses 'Setloholo'. For all the three Sotho languages the terms do not denote gender.

Table 8d

The table below consists of dictionary entries for the Setswana kinship terms found in Table 8a above

Term	South African Multi-language Dictionary	Setswana English Dictionary	Dikišinari ya Setswana English Afrikaans	Thanodi ya Setswana
Ngwanaa ngwanake	No entry	No entry	No entry	Ngwana yo o lebaganweng ke go bitsa motsadi yo o tshotseng motsadi wa gagwe a re nkoko kgotsa ntatemogolo

The term 'Ngwanangwanake' (grandchild) is entered in some dictionaries as 'Motlogolo' (also meaning grandchild). Literally the term means 'child of my child', and does not show gender differentiation. This term has not been satisfactorily treated in the Setswana dictionaries. Only one dictionary, Thanodi ya Setswana, has an entry.

3.10 MAN’S GRANDPARENTS ON HIS MOTHER’S SIDE

The information presented below shows the relationship between the man and his maternal grandparents. The recurring terms here are ‘Rremogolo’ (grandfather) and ‘Mmemogolo’ (grandmother), which are used for two different generations. They are used to refer to great-grandparents as well as to grandparents. The Ego’s wife (r2.2) uses the same terms as her husband, though the parents would refer to her as ‘Ngwetsi’ (daughter-in-law).

Diagram 9

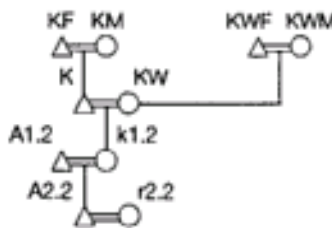

Table 9a

Relations systems of **Setswana** speakers: K-line: Parental generation (Man’s grandparents on his mother’s side).

Forms of address/variables (Referral terms between brackets)

F2-generation*	Ego A2.2 (male)	Ego r2.2 (female)
Older generation		
Great-grandfather	KF**Rremogolo/Ntatemogolo/ Rremogologolwane/Ntatemogolo- golwane (rraagwe ntatemogolo)	As by Ego A2.2 with optional addition of ‘wa mogatsake’ (of my
	KWF Rremogolo/Ntatemogolo/Rre- mogologolwane/Ntatemogolo- golwane (rraagwe mmemogolo)	

Great-grandmother	KM Mmemogolo/Mmemogolo golwane (mmaagwe ntatemogolo)	
	KWM Mmemogolo/Mmemogolo golwane (mmaagwe mmemogolo)	
Younger Generation		
Grandfather	K Rremogolo/Ntatemogolo (rraagwe mme)	As by above
Grandmother	KW Mmemogolo (mmaagwe mme)	As by above

The Setswana terms ‘Rremogolo’ (grandfather) and ‘Mmemogolo’ (grandmother) are used to refer to great-grandparents as well as to grandparents. There are also the terms ‘Rremogologolwane’ or ‘Ntatemogologolwane’ (great-grandfather) and ‘Mmemogologolwane’ (great-grandmother), which are not commonly used in everyday speech.

Table 9b

Relations systems of **Northern Sotho** speakers: K-Line: Parental generation (Man’s grandparents on his mother’s side)

Forms of address/variables (Referral terms between brackets)

F2-generation*	Ego A2.2 (male)	Ego r2.2 (female)
Older generation		
Great-grandfather	KF**Rakgolokhukhu (Mmelega rakgolo)	As by for A2.2
	KWF Rakgolokhukhu (Mmelega koko)	
Great-grandmother	KM Mmakgolokhukhu (Mmelega rakgolo)	
	KWM Mmakgolokhukhu (Mmelega koko)	

Younger Generation		
Grandfather	K Rakgolo/Tatemogolo (Mmelega mma)	Mmelega matswale
Grandmother	KW Mmakgolo/Koko (Mmelega mma)	Mmelega matswale

(from Van Wyk and Prinsloo,

1992:52)

In Northern Sotho the terms for great-grandparents are ‘Rakgolokhukhu’ (great-grandfather) and ‘Mmakgolokhukhu’ (great-grandmother).

Table 9c

Relations systems of **Southern Sotho** speakers: K-line: Parental generation (Man’s grand-parents on his mother’s side).

Forms of address/variables (Referral terms between brackets)

F2-generation*	Ego A2.2 (male)	Ego r2.2 (female)
Older generation		
Great grand-father	KF** Ntatemoholo/Ntatantatamoholo (ntate oa ntatemoholo)	As by Ego A2.2 with optional addition of ‘oa monna oa ka’ (of my husband)
	KWF Ntatemoholo (ntate oa nkhono)	
Great grand-mother	KM Nkhono (mme oa ntatemogolo)	
	KWM Nkhono (mme oa nkhono)	
Younger Generation		
Grandfather	K Ntatemoholo (ntate oa mme)	
Grandmother	KW Nkhono (mme oa mme)	

The Southern Sotho term ‘Nkhono’ (grandmother) is used for both grandmother and great-grandmother.

Differences and similarities

The main difference among the three Sotho languages is the use of the terms ‘Ntatemogologolwane’ or ‘Rremogologolwane’ and ‘Mmemogologolwane’ (great-grandfather and great-grandmother) in Setswana; ‘Rakgolokhukhu’ and ‘Mmakgolokhukhu’ (great-grandfather and great-grandmother) in Northern Sotho; as well as ‘Ntatantamoholo’ (great-grandfather), in Southern Sotho.

Table 9d

In this table we find dictionary entries for the Setswana kinship terms used in Table 9a above

Term	South African Multi-language Dictionary	Setswana English Dictionary	Dikišinari ya Setswana English Afrikaans	Thanodi ya Setswana
Rremogolo/Ntatemogolo	Grandfather	No entry	Grandfather; father's elder brother	Rraagwe ntate
Mmemogolo	Grandmother	No entry	Grandmother; mother's elder sister	Mmaagwe mme; nkoko; mogolo'a mme

In Setswana the terms ‘Rremogolo’ (grandfather) and ‘Mmemogolo’ (grandmother) are used to refer to two generations. The terms for great-grandparents are not entered in the dictionaries. The treatment of these terms is almost eighty percent (80%) in the dictionaries.

3.11 MAN’S PARENTS AND HIS MOTHER’S BROTHERS AND SISTERS

The relationship shown below is between the man and his maternal uncles and aunts. He refers to all his mother’s brothers as ‘Malome’ (uncle). For his mother’s elder sister(s) he uses the term ‘Mmemogolo’ (literally meaning older mother), and his mother’s younger sister(s) is ‘Mmangwane’ or ‘Mmane’ (aunt). The same applies to the Ego’s wife (r2.2).

Diagram 10

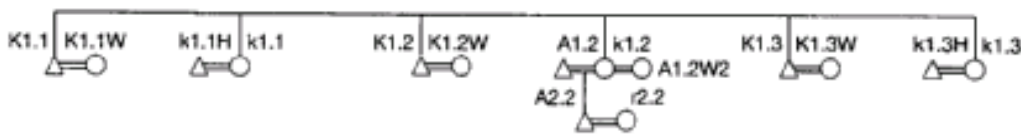

Table 10a

Relations systems of **Setswana** speakers: K-line: First filial generation (Man’s parents and his mother’s brothers and sisters)

Forms of address/variables (Referral terms between brackets)

F2-generation*	Ego A2.2 (male)	Ego r2.2 (female)
Older generation		
Uncle	K1.1** Malome (yo mogolo)	As by Ego A2.2 with optional addition of ‘wa mogatsake’ (of my husband)
Aunt	K1.1W Mogatsa malome/Mmamalome (yo mogolo)	
Aunt	k1.1 Mmamogolo	
Uncle	k1.1H Rremogolo (mogatsa mmemogolo)	
Uncle	K1.2 Malome (wa bobedi)	
Aunt	K1.2W Mogatsa malome (wa bobedi)	

Parents		
Father	A1.2 Ntate/Rre	Ntate/Ratsale
Mother	k1.1 Mme	Mme/Matsale
Father's second wife	A1.2W2 Mmangwane/Mmane (mogatsa ntate wa bobedi)	Mmane/Mogatsa ratsale yo monnye
Younger Generation		
Uncle	K1.3 Malome (yo monnye)	As by Ego A2.2 with optional addition of 'wa mogatsake' (of my husband)
Aunt	K1.3W Mogatsa malome/ Mmamalome	
Aunt	k1.3 Mmangwane/Mmane (monnawe mme wa mosadi)	
Uncle	k1.3H Rangwane (mogatsa mmangwane)	

There are situations where kinship is expressed in one word or a phrase, for example, 'Mmamalome' or 'Mogatsa malome', both accepted in referring to mother's brother's wife.

Table 10b

Relations systems of **Northern Sotho** speakers: K-line: First filial generation (Man's parents and his mother's brothers and sisters)

Forms of address/variables (Referral terms between brackets)

F2-generation*	Ego A2.2 (male)	Ego r2.2 (female)
Older generation		
Uncle	K1.1**Malome (yo mogolo)	Same as for Ego A2.2
Aunt	K1.1W Mogatša malome (mmamalome)	
Aunt	k1.1 Mmamogolo	
Uncle	k1.1H Mogatša' mmamogolo/ Ramogolo	
Uncle	K1.2 Malome (yo mogolwane)	
Aunt	K1.2W Mogatša malome/Mmamalome	
Parents		
Father	A1.2 Tate	Tate/Ratswale
Mother	k1.2 Mme/Mma	Mme/Mma/Matswale
Father's second wife	A1.2W2 Mmane/Mmangwane (Mogatša tate wa bobedi)	Mmane/Mmangwane (mogatša ratswale wa bobedi)
Younger Generation		
Uncle	K1.3 Malome (yo monyane)	Same as for Ego A2.2 with optional addition of 'wa mogatšaka' (of my husband)
Aunt	K1.3W Mogatša malome/Mmamalome	
Aunt	k1.3 Mmangwane/Mmane	
Uncle	k1.3H Mogatša mmangwane/Rangwane	

(from Van Wyk and Prinsloo,

1992:53)

The pattern of kinship terms used in the table above is the same as that of Setswana, as shown on Table 10a.

Table 10c

Relations systems of **Southern Sotho** speakers: K-line: First filial generation (Man's parents and his mother's brothers and sisters)

Forms of address/variables (Referral terms between brackets)

F2-generation*	Ego A2.2 (male)	Ego r2.2 (female)
Older generation		
Uncle	K1.1** Malome (ya moholo)	Same for Ego A2.2 with optional addition of 'oa monna ka' (of my husband)
Aunt	K1.1W Mosadi oa malome (ya moholo)	
Aunt	k1.1 Nkhono	
Uncle	k1.1H Monna oa nkhono	
Uncle	K1.2 Malome (oa bobedi)	
Aunt	K1.2W Mosadi oa malome (oa bobedi)	
Parents		
Father	A1.2 Ntate	Ntate/Ratsale
Mother	k1.1 Mme	Mme/Matsale
Father's second wife	A1.2W2 Mmangwane/Moqekoa (mosadi oa ntate oa bobedi)	Mmangwane (mosadi oa ratsale ya monnyane)
Younger Generation		
Uncle	K1.3 Malome (ya monnyane)	Same as Ego A2.2
Aunt	K1.3W Mosadi oa malome	
Aunt	k1.3 Mmangwane	
Uncle	k1.3H Rangwane (monna oa mmangwane)	

There is a difference between Setswana and Southern Sotho, the latter has a term for father's second wife which is 'Moqekoa', not found in Setswana.

Differences and similarities

There is a difference in spelling between Northern Sotho and the other Sotho languages for the terms 'Ratswale' (father-in-law) and 'Matswale' (mother-in-law). Setswana and Southern Sotho do not have 'w', hence the terms are spelt 'Ratsale' and 'Matsale'. For all the three languages the term 'Mmangwane' is used to refer to father's second wife, though the actual meaning of the term is mother's younger sister, or the wife of father's younger brother.

Table 10d

The following table presents dictionary entries for the Setswana kinship terms found in Table 10a above

Term	South African Multi- language Dictionary	Setswana English Dictionary	Dikišinari ya Setswana English Afrikaans	Thanodi ya Setswana
Malome	Uncle	No entry	Mother's brother	Kgaitadi'a mmaagwe motho
Mmamalome/ Mogatsa malome	No entry	No entry	No entry	No entry
Mogatsa mmemogolo/ rremogolo	No entry	No entry	No entry	No entry
Mmemogolo	Grandmother	No entry	Grandmother; mother's elder sister	Mmaagwe mme; nkoko; mogolo'a mme
Ntate/rre	Father	No entry	Rra/father	Ntate; monna yo ntsetseng

Mme	Mother	Mother	My mother	Motsadi wa me wa mosadi
Mmangwane	No entry	No entry	Mother's younger sister	Monna'a mme
Rangwane	No entry	No entry	Father's younger brother	Monnawe ntate

There are no entries for mother's elder sister's husband 'Rremogolo' and uncle's wife 'Mogatsa malome' or 'Mmamalome'. In this case only expressions are used to refer to these relatives. The term 'Mmangwane' (mother's younger sister) is used in Table 10a to refer to the father's second wife, as well as to the wife of the father's younger brother. 'Rangwane' (uncle) here refers to aunt's husband, not father's younger brother as is usually the case. The observation here is that ambiguity has not been taken into consideration in the treatment of the kinship terms. But most of the used dictionaries have entries for the terms, about sixty percent (60%) of the terms have been treated.

3.12 MAN’S MOTHER’S BROTHERS’ AND SISTERS’ CHILDREN

The relationship shown in the diagram and table to follow is between the man and his cousins on his mother’s side, children of his mother’s brothers and sisters. The most dominant terms in this relationship are ‘Ntsala’ (cousin), ‘Nkgonne’ or ‘Mogolole’ (mother’s elder sister’s child) and ‘Nnake’ (mother’s younger sister’s child). The term ‘Ntsala’ (cousin) is only used to refer to mother’s brothers’ children ‘bana ba malome’.

Diagram 11

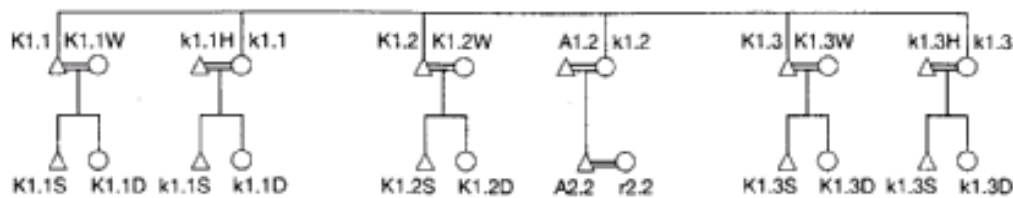

Table 11a

Relations systems of **Setswana** speakers: K-line: Two filial generations (Man’s mother’s brothers and sisters’ children)

Forms of address/variables (Referral terms between brackets)

F2-generation*	Ego A2.2 (male)	Ego r2.2 (female)
Older generation		
Cousin	K1.1S** Ntsala (ngwana wa ga malome)	Ntsala (Morwa wa malomaagwe mogatsake)
Cousin	K1.1D Ntsala(ke) (morwadi-a-malome)	Same as for Ego A2.2
Cousin	k1.1S Mogolole/Nkgonne/Nnake (ngwana wa ga mmemogolo)	

Cousin	k1.1D Mogolole/Nkgonne (morwadi-a-mmemogolo)	
Cousin	K1.2S As for K1.1S	As for K1.1S
Cousin	K1.2D As for K1.1D	As for K1.1D
Younger Generation		
Cousin	K1.3S Ntsala (ngwana wa ga malome yo monnye)	Same as K1.1S
Cousin	K1.3D Ntsala	Same as K1.1D
Cousin	k1.3S Mogolole/Nnake (ngwana wa ga mmangwane)	
Cousin	k1.3D Mogolole/Nnake	

The term 'Morwadi' (daughter) is normally used with '-a-' which is an elision of 'wa ga'. It indicates possession as in the table above.

Table 11b

Relations systems of **Northern Sotho** speakers: K-line: Two filial generations (Man's mother's brothers and sisters' children)

Forms of address/variables (Referral terms between brackets)

F2-generation*	Ego A2.2 (male)	Ego r2.2 (female)
Older Generation		
Cousin	K1.1S**Motswala/Mogolle Moratho/Nnake	Motswala/Moratho/Nnake (Morwa wa malome wa mogatšake)
Cousin	K1.1D Motswala/Moratho Monyanana (Morwedi wa malome yo mogolo)	Same as for A2.2 with optional addition of 'wa mogatšaka' (of my husband)

Cousin	k1.1S Mogolle/Moratho/Nnake (Morwa wa mmamogolo)	
Cousin	k1.1D Mogolle/Moratho/Monyanan a (Morwedi wa mmamogolo)	
Cousin	K1.2S As for K1.1S	
Cousin	K1.2D As for K1.1D	
Younger Generation		
Cousin	K1.3S As for K1.1S	Same as A2.2 with optional addition of 'wa mogatšaka' (of my husband)
Cousin	K1.3D As for K1.1D	
Cousin	k1.3S As for k1.1S replace 'wa Mmamogolo' with 'wa Mmangwane/Mmane'	
Cousin	k1.3D As k1.1D	

(from Van Wyk and Prinsloo,

1992:53)

The table above shows no marked differences between the Sotho languages, except spelling for 'Motswala' (cousin) in Northern Sotho, which in Setswana is 'Ntsala'.

Table 11c

Relations systems of **Southern Sotho** speakers: K-line: Two filial generations (Man's mother's brothers and sisters' children)

Forms of address/variables (Referral terms between brackets)

F2-generation*	Ego A2.2 (male)	Ego r2.2 (female)
Older generation		
Cousin	K1.1S** Motswala (ngwana oa malome)	Motswala (morwa oa malome oa monna aka)

Cousin	K1.1D Motswala (moradi oa malome)	
Cousin	k1.1S Kgaitsemi (ngwana oa nkhono)	
Cousin	k1.1D Moholwane/Kgaitsemi (moradi oa nkhono)	
Cousin	K1.2S As for K1.1S	As for K1.1S
Cousin	K1.2D As for K1.1D	As for K1.1D
Younger Generation		
Cousin	K1.3S Motswala (ngwana wa malome yo monnyane)	As for K1.1S
Cousin	K1.3D Motswala	As for K1.1D
Cousin	k1.3S Moholwane (ngwana oa mmangwane)	
Cousin	k1.3D Moholwane	

The table above contains the terms 'Moholwane' (elder brother) and 'Nkhono' (grandmother or mother's elder sister). The kinship pattern is the same as that of Setswana.

Differences and similarities

In Setswana the term 'Ntsala' (cousin) is normally used with the possessive concord, for instance, 'Ntsalake' (my cousin) or 'Ntsalao' (your cousin). Elision has taken place in both terms 'Ntsalake', which is supposed to be 'Ntsala wa ka/me' and 'Ntsalao' which is supposed to be 'Ntsala wa gago'. The Northern Sotho and Southern Sotho use 'Motswala' (cousin). All the three languages have the term 'Kgaitsemi' (brother or sister) but have for the difference in spelling, Setswana having 'Kgaitsemi'.

Table 11d

The following table contains dictionary entries for Setswana kinship terms found in Table 11a above

Term	South African Multi- language Dictionary	Setswana English Dictionary	Dikišinari ya Setswana English Afrikaans	Thanodi ya Setswana
Ntsala	Nephew or niece	No entry	Mother's brother's child; father's sister's child	Ngwana wa ga malome
Mogolole/Nkgonne	No entry	No entry	Elder brother or sister	Mosimane yo motona mo lwapeng a tewa ke monnawe wa mosimane
Morwa	Son	No entry	Son	Ngwana wa motho wa mosimane
Morwadi	Daughter	Morwadi; daughter	Daughter	Ngwana wa motho wa mosetsana
Nnake	No entry	No entry	My younger brother or sister	Ngwana wa batsadi ba me yo o tsetsweng fa morago ga me

About sixty-five percent (65%) of the Setswana kinship terms have been treated in the dictionaries used.

3.13 CONCLUSION

In conclusion, the researcher has used diagrams and tables in this chapter to highlight similarities and differences in kinship terms between the three Sotho languages. As far as the treatment of the terms in the dictionaries is concerned, this chapter shows that two out of the four dictionaries used have made a satisfactory effort to create entries for kinship terms featured in the tables. These are Dikišinari ya Setswana English Afrikaans by Snyman, Shole and le Roux and Thanodi ya Setswana by Kgasa and Tsonope. The conclusion that can be drawn from this is that as more dictionaries are published, it is likely that many (if not all) kinship terms will be treated. This is so because these dictionaries are more recent, compared to the other two that have not made a satisfactory effort in treating kinship terms.

One main setback observed in the treatment of kinship terminology in dictionaries is the use of expressions or phrases to address relatives. It is not easy to make an entry for an expression such as ‘mogatsake wa bobedi’ (my second wife) or ‘mogatsa nnake or nkgonne’ (spouse of either younger brother or younger sister or spouse of either elder brother or elder sister).

Since the focus in this chapter is on the Ego (husband) and his relatives, some kinship terms appear in more than one relationship table because the researcher looked at relatives on the maternal side as well as the paternal side. So, it becomes evident that a term like ‘Rremogolo’ (grandfather) appears on Table 1a which shows the man’s grandparents on his father’s side, as well as on Table 9a which shows the man’s grandparents on his mother’s side. Likewise, Table 2a and Table 10a both contain the terms uncle and aunt. In Table 2a, uncle refers to ‘Rremogolo’ (father’s elder brother) and it is also used to refer to ‘Rangwane’ (father’s younger brother), or even ‘Monna wa ga Rakgadi’ (aunt’s husband). On a different note, the maternal relationship as depicted by Table 10a has the same term uncle used to refer to ‘Malome’ (mother’s brother) which can have the inscription ‘yo mogolo’ (older) or ‘yo monnye’ (younger) depending on whether he is older or younger than the mother. The same term refers to ‘Rangwane’ (mother’s younger sister’s husband). The term aunt appears on Table 2a

to refer to 'Mmemogolo' (father's elder brother's wife) and also refers to 'Rakgadi' (father's sister), as well as to 'Mogatsa rangwane' (father's younger brother's wife) and in both tables it can be used to address father's second wife. On a similar note the term aunt features in Table 10a to refer to 'Mmemogolo' (mother's elder sister); also refers to 'Mmamalome' (maternal uncle's wife) and lastly refers to 'Mmangwane' (mother's younger sister).

All in all, there is not much difference in the kinship terminologies for the three sister languages, as is evident in this chapter. It is clear that the terms 'Mmemogolo' and 'Rremogolo' are used in Setswana and Southern Sotho to refer to great-grandparents, grandparents as well as to mother's sister and father's brother respectively. Northern Sotho has specific terms for great-grandparents, which are 'Mmakgolokhukhu' and 'Rakgolokhukhu'. Another difference is the use of the diacritic sign 'š' in Northern Sotho which is not commonly found in Setswana and Southern Sotho. A notable difference between Southern Sotho and its sister languages is the term 'Mogatsa' (Setswana) or 'Mogatša' (Northern Sotho). Southern Sotho uses the expression 'Monna oa' (husband of) and 'Mosadi oa' (wife of) to refer to spouses. Generally, the three Sotho languages have got similar relationship patterns, just slight differences in terminology.

CHAPTER 4

DIAGRAMS AND TABLES OF MAN'S WIFE'S RELATIVES (EGO r2.2)

4.1 INTRODUCTION

This chapter will be a follow-up of the diagrams and tables shown in the previous chapter. Diagrams 12 to 19 focus on the relations of the man's wife (Ego r2.2). In these diagrams and tables, the wife will be the centre from which each relationship is interpreted and kinship terms allocated. As in the previous chapter, every diagram is followed by three tables, one giving Setswana kinship terms, followed by one with Northern Sotho terms, and then the third one giving the Southern Sotho terms. Below these tables will be a discussion of the differences and similarities observed between Setswana and the other Sotho languages. At the end, there is a table with dictionary entries, followed by an evaluation of the quality of the treatment of the Setswana kinship terms.

4.2 MAN'S WIFE'S GRANDPARENTS ON HER FATHER'S SIDE

The diagram below depicts relations between the man's wife (r2.2) and her paternal grandparents. The dominant terms here are 'Mmemogolo' (grandmother) and 'Ntatemogolo' or 'Remogolo' (grandfather). The Ego (A2.2) uses the same terms as his wife, with the optional addition of 'wa mogatsake' (of my wife). On the other hand, the grandparents refer to him as 'Mogwe' (son-in-law).

Diagram 12

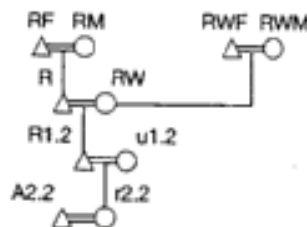

Table 12a

Relations systems of **Setswana** speakers: R-line: Parental generation (Wife's grandparents on her father's side)

Forms of address/variables (Referral terms between brackets)

F2-generation*	Ego A2.2 (male)	Ego r2.2 (female)
Older Generation		
Great-grandfather	**RF	Rremogolo/Ntatemogolo
	RWF	Rremogolo (rraagwe nkoko)
Great-Grandmother	RM As by r2.2 with optional addition of 'wa mogatsake' (of my wife)	Mmemogolo/Nkoko (mmaagwe ntatemogolo/motsala ntatemogolo)
	RWM	Mmemogolo (mmaagwe nkoko/motsala nkoko)
Younger Generation		
Grandfather	R	Rremogolo/Ntatemogolo
Grandmother	RW	Mmemogolo/Nkoko (motsala ntatemogolo)

The terms 'Mmemogolo' (grandmother) and 'Rremogolo' (grandfather) are used in two generations, for great-grandparents as well as for grandparents. The latter can also be referred to as 'Mmemogologolwane' (great-grandmother) and 'Rre/Ntatemogologolwane' (great-grandfather), but these two terms are not commonly used. The optional addition of 'wa mogatsake' also applies for relatives of the male partner, Ego A2.2.

Table 12b

Relations systems of **Northern Sotho** speakers: R-line: parental generation (Wife's grandparents on her father's side).

Forms of address/variables (Referral terms between brackets)

F2-generation*	Ego A2.2 (male)	Ego r2.2 (female)
Older generation		
Great grandfather	**RF	Rakgolokhukhu/Tate mogolo (Mmelega rakgolo)
	RWF As by r2.2 with optional addition of 'wa mogatšaka' (of my wife)	Rakgolokhukhu (Mmelega koko)
Great grandmother	RM	Mmakgolokhukhu (Mmelega rakgolo)
	RWM	Mmakgolokhukhu (Mmelega koko)
Younger Generation		
Grandfather	R	Rakgolo/Tatemogolo (Mmelega tate)
Grandmother	RW	Mmakgolo/Koko (Mmelega tate)

(from Van Wyk and Prinsloo, 1992:53)

The optional addition of 'wa mogatšaka' (of my wife) is used for relatives of the man's wife in the same way as (of my husband) was used for relatives of the man.

Table 12c

Relations systems of **Southern Sotho** speakers: R-line: Parental generation (Wife's grandparents on her father's side)

Forms of address/variables (Referral terms between brackets)

F2-generation*	Ego A2.2 (male)	Ego r2.2 (female)
Older generation		
Great-grandfather	**RF	Ntatemoholo/Ntatantatemoholo
	RWF	Ntatemoholo (ntate oa nkhono)
Great-Grandmother	RM As by r2.2 with optional addition of 'oa mosadi oa ka' (of my wife)	Nkhono (mme oa ntatemoholo)
	RWM	Nkhono (mme oa nkhono)
Younger Generation		
Grandfather	R	Ntatemoholo
Grandmother	RW	Nkhono

The optional addition of 'oa mosadi oa ka' (of my wife) can be used when the man addresses his in-laws.

Differences and similarities

The patterns of kinship terms for the three Sotho languages is almost the same. The main difference is in the use of the terms 'Remogolo' and 'Ntatemogolo' which are used interchangeably in Setswana to mean grandfather where Northern Sotho uses 'Ramogolo' and 'Tatemogolo' (grandfather), as well as 'Mmakgolo' (grandmother). These terms are not found in Southern Sotho, which uses 'Nkhono' (grandmother), a term not found in the other two languages.

Table 12d

Below is a table on Setswana kinship terms found in Table 12a as entered in different dictionaries.

Term	South African Multi- language Dictionary	Setswana English Dictionary	Dikišinari ya Setswana English Afrikaans	Thanodi ya Setswana
Rremogolo	Grandfather	No entry	Grandfather; father's elder brother	Rraagwe ntate
Mmemogolo	Grandmother	No entry	Grandmother; mother's elder sister	Mmaagwe mme; nkoko; mogolowe mme

Like a man's own grandparents, his wife's grandparents are predominantly 'Mmemogolo' (grandmother) and 'Rremogolo' (grandfather). These terms are used for great-grandparents as well as for grandparents. The treatment for the terms entered is about fifty percent (50%), which is satisfactory.

4.3 WIFE’S PARENTS’ BROTHERS AND SISTERS

The Ego (A2.2) in the relationship below refers to his father-in-law’s brothers and sisters in the same way as his wife (r2.2) does, or he just refers to them as parents-in-law. The recurrent terms in this relationship are ‘Rakgadi’ (father’s sister), ‘Rangwane’ (father’s younger brother) and ‘Rremogolo’ (father’s elder brother).

Diagram 13

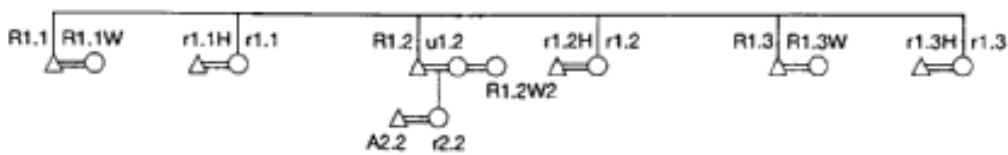

Table 13a

Relations systems of **Setswana** speakers: R-line: First filial generation (Wife’s parents’ brothers and sisters)

Forms of address/variables (Referral terms between brackets)

F2-generation*	Ego A2.2 (male)	Ego r2.2 (female)
Older generation		
Uncle	R1.1**	Rremogolo/Ntatemogolo (mogolowe ntate)
Aunt	R1.1W As by r2.2 with optional Addition of ‘wa mogatsake’ (of my wife)	Mmemogolo (mogatsa rremogolo)
Aunt	r1.1	Rakgadi (yo mogolo)
Uncle	r1.1H	Rakgadi wa monna (mogatsa rakgadi)

Parents		
Father	R1.2 Mogwegadi/Ntate	Ntate/Rre
Mother	u1.2 Mogwegadi/Mme	Mme
Father's second wife	R1.2W2 Mmangwane/Mmane (mogatsa mogwegadi wa me wa bobedi)	Mmangwane/Mmane (mogatsa ntate yo monnye)
Younger Generation		
Aunt	r1.2	Rakgadi (yo monnye)
Uncle	r1.2H As by r2.2 with optional addition of 'wa mogatsake' (of my wife)	Rakgadi
Uncle	R1.3	Rangwane (monnawe ntate)
Aunt	R1.3W	Mmangwane/Mmane (mogatsa rangwane)
Aunt	r1.3	Rakgadi
Uncle	r1.3H	Rakgadi wa monna

In Setswana, 'Ratsale' (father-in-law) and 'Matsale' (mother-in-law) are only used to refer to a woman's in-laws. The man uses the term 'Mogwegadi' for both his in-laws.

Table 13b

Relations systems of **Northern Sotho** speakers: R-line: First filial generation (Wife's parents' brothers and sisters)

Forms of address/variables (Referral terms between brackets)

F2-generation*	Ego A2.2 (male)	Ego r2.2 (female)
Older Generation		
Uncle	R1.1**	Ramogolo
Aunt	R1.1W As by r2. 2 with optional addition of ‘wa mogatšaka’(of my wife)	Mmamogolo (Mogatša ramogolo)
Aunt	r1.1	Rakgadi (yo mogolo)
Uncle	r1.1H	Rakgadi (Mogatša rakgadi)
Parents		
Father	R1.2 Ratswale/Tate	Tate
Mother	u1.2 Mme/Mma/Matswale	Mme/Mma
Father’s second wife	R1.2W2 Mmane/Mmangwane (Mogatša ratswale wa bobedi)	Mmane/Mmangwane (Mogatša tate wa bobedi)
Younger Generation		
Aunt	r1.2	Rakgadi (yo monyane)
Uncle	r1.3H	Rakgadi (Mogatša rakgadi)

(from Van Wyk and Prinsloo,

1992:54)

The kinship pattern here is the same as that of Setswana.

Table 13c

Relations systems of **Southern Sotho** speakers: R-line: First filial generation (Wife’s parents’ brothers and sisters)

Forms of address/variables (Referral terms between brackets)

F2-generation*	Ego A2.2 (male)	Ego r2.2 (female)
Older generation		
Uncle	R1.1**	Ntatemoholo (moholwane oa ntate)

Aunt	R1.1W As by r2.2 with optional addition of 'oa mosadi oa ka' (of my wife)	Nkhono (mosadi oa ntatemoholo)
Aunt	r1.1	Rakgadi (ya mogolo)
Uncle	r1.1H	Monna oa rakgadi
Parents		
Father	R1.2 Ntate	Ntate
Mother	u1.2 Mme	Mme
Father's second wife	R1.2W2 Mmangwane (mosadi oa ntate wa bobedi)	Mmangwane/Moqekwa (mosadi oa ntate ya monnyane)
Younger Generation		
Aunt	r1.2	Rakgadi (ya monnyane)
Uncle	r1.2H As by r2.2 with optional addition of 'oa mosadi oa ka' (of my wife)	Rakgadi
Uncle	R1.3	Rangwane (moena oa ntate)
Aunt	R1.3W	Mmangwane (mosadi oa rangwane)
Aunt	r1.3	Rakgadi
Uncle	r1.3H	Monna oa rakgadi

Southern Sotho does not use the term 'Mogatsa' for spouse. An unfamiliar term in the above table is 'Moena' (younger brother), as used to describe 'Rangwane' (father's younger brother).

Differences and similarities

There is a difference in the way the man addresses his in-laws between Setswana and Northern Sotho. In the former, the term 'Mogwegadi' is used, whereas in the latter the terms 'Matswale' (mother-in-law) and 'Ratswale' (father-in-law) are used. In Southern

Sotho there is 'Matswale' (mother-in-law), which is only used by the woman referring to her mother-in-law, and 'Mohwehadi' (parent-in-law) used by the man referring to his wife's parents. Basically, the kinship pattern is the same for all the three Sotho languages.

Table 13d

The table below shows dictionary entries for the Setswana kinship terms used in Table 13a above

Term	South African Multi-language Dictionary	Setswana English Dictionary	Dikišinari ya Setswana English Afrikaans	Thanodi ya Setswana
Rremogolo	Grandfather	No entry	Grandfather; father's elder brother	Rraagwe ntate
Mmemogolo	Grandmother	No entry	Grandmother; mother's elder sister	Mmaagwe mme; nkoko; mogolowe mme
Rakgadi	No entry	No entry	Father's sister or her husband	Kgaitadi'a ntate
Ntate/Rre	Father	No entry	Rra; father	Ntate; monna yo o ntsetseng
Mme	Mother	Mother	My mother	Motsadi wa me wa mosadi
Mogwegadi	Mother-in-law	No entry	No entry	Motsadi wa mosadi yo o nyetsweng a tewa ke monna wa ngwana wa gagwe

Mmangwane	No entry	No entry	Mother's younger sister	Monna'a mme
Rangwane	No entry	My uncle	Father's younger brother	Monnawe ntate

In this table some terms have been entered in dictionaries with only one meaning while the terms have more than one meaning. For example, 'Rangwane' (uncle) here refers to aunt's husband, and not father's younger brother, 'Mmangwane' (mother's younger sister) is used here to refer to paternal uncle's wife, and 'Mmemogolo' (grandmother) here refers to wife of father's elder brother. The general observation by the researcher then is that most Setswana dictionaries ignore ambiguity. This can mislead a person reading the information if she or he does not master the language. About seventy percent (70%) of the terms do have entries in the dictionaries.

4.4 WIFE’S BROTHERS AND SISTERS

This set-up is similar to that of the Ego’s (A2.2) own brothers and sisters. The dominant terms used are ‘Nkgonne’ or ‘Mogolole’ (elder sister), ‘Nnake’ (younger brother or sister) and ‘Kgaityadi’ (brother or sister). The other term recurring here is ‘Mogadibo’ (brother’s wife).

Diagram 14



Table 14a

Relations systems of **Setswana** speakers: R-line: Two filial generations (Wife’s brothers and sisters)

Forms of address/variables (Referral terms between brackets)

F2-generation*	Ego A2.2 (male)	Ego r2.2 (female)
Older Generation		
Brother	R2.1** Mogolole (mogolowe mogatsake)	Kgaityadi (yo mogolo)
Sister-in-law	R2.1W Mogolole/Nkgonne (mogatsa kgaityadi wa mogatsake)	Mogadibo
Sister	r2.1 Mogolole	Mogolole/Nkgonne
Brother-in-law	r2.1H Mogolole (mogatsa mogolowe mogatsake)	Mogolole/Mogatsa nkgonne
Brother	R2.2 Mogolole (kgaityadi- a- mogatsake)	Kgaityadi

Sister-in-law	R2.2W Mogolole (mogatsa mogolowe mogatsake)	Mogadibo (mogatsa kgaitsadiake)
Ego	A2.2 -- (Nna)	Mogatsake (monna wa me)
Self	r2.2 Mogatsake	--- (Nna)
Younger Generation		
Brother	R2.3 Nnake (monnawe mogatsake)	Kgaitšadi (yo monnye)
Sister-in-law	R2.3W Nnake (mogatsa monnawe mogatsake)	Mogadibo
Sister	r2.3 Nnake (monnawe mogatsake)	Nnake (wa gofejane)
Brother-in-law	r2.3H Nnake (mogatsa monnawe mogatsake)	Nnake (mogatsa nnake)

The terms shown in the above table depict no difference between Setswana, Southern Sotho and Northern Sotho.

Table 14b

Relations systems of **Northern Sotho** speakers: R-line: Two filial generations (Wife's brothers and sisters).

Forms of address/variables (Referral terms between brackets)

F2-generation*	Ego A2.2 (male)	Ego r2.2 (female)
Older generation		
Brother	R2.1**Molamo/Mogolle wa mogatšaka	Kgaitšedi/Mogolwake (yo mogolo)
Sister-in-law	R2.1W Molamo (Mogatša wa kgaitšedi wa mogatšaka)	Mogadibo/Molamo (Mogatša kgaitšedi yo mogolo)

Sister	r2.1 Mogolle (wa mogatšaka)	Mogolle/Mogolwake
Brother-in-law	r2.1H Molamo (Mogatša wa mogolle wa mogatšaka)	Molamo (Mogatša mogolwake)
Brother	R2.2 Molamo (Mogolle wa mogatšaka)	Kgaitšedi (yo mogolwane)
Sister-in-law	R2.2W Molamo	Mogadibo (yo mogolwane)
Ego	A2.2 --- (Nna)	Mogatsaka
Self	r2.2 Mogatšaka	--- (Nna)
<u>Younger Generation</u>		
Brother	R2.3 Molamo (Moratho wa mogatšaka)	Kgaitšedi/Moratho/Nnake
Sister-in-law	R2.3W Molamo (Mogatša moratho wa mogatšaka)	Mogadibo (Mogatša moratho)
Sister	r2.3 Moratho (Monyanana wa mogatšaka)	Moratho/Monyanana
Brother-in-law	r2.3H Molamo (Mogatša monyanana wa mogatšaka)	Molamo (Mogatša moratho)

(from Van Wyk and Prinsloo, 1992:55)

Basically, there are no differences between the kinship terms shown in the above table and those in Table 14a, except for the use of the terms ‘Molamo’ (brother-in-law) and ‘Moratho’ (younger brother or sister), which are used in Northern Sotho and Southern Sotho, but not in Setswana.

Table 14c

Relations systems of **Southern Sotho** speakers: R-line: Two filial generations (Wife’s brothers and sisters)

Forms of address/variables (Referral terms between brackets)

F2-generation*	Ego A2.2 (male)	Ego r2.2 (female)
Older Generation		
Brother	R2.1**Moholwane (moholwane oa mosadi oa ka)	Kgaitsemi (ya moholo)
Sister-in-law	R2.1W Moholwane (mosadi oa kgaitsemi wa mosadi oa ka)	Molamo
Sister	r2.1 Moholwane	Moholwane
Brother-in-law	r2.1H Moholwane (same as R2.1W above)	Moholwane
Brother	R2.2 Moholwane (kgaitsemi oa mosadi oa ka)	Kgaitsemi
Sister-in-law	R2.2W Moholwane (mosadi oa moholwane oa mosadi oa ka)	Molamo (mosadi oa kgaitsemi)
Ego	A2.2 --- (Nna)	Monna oa ka
Self	r2.2 Mosadi oa ka	--- (Nna)
Younger Generation		
Brother	R2.3 Kgaitsemi (ya monnyane ho mosadi oa ka)	Kgaitsemi (ya monnyane)
Sister-in-law	R2.3W Mosadi oa kgaitsemi oa mosadi oa ka	Molamo
Sister	r2.3 Nnake (ngwana oa bo mosadi oa ka)	Nnake (wa kgorula)
Brother-in-law	r2.3H Nnake (monna oa ngwana oa bo mosadi oa ka)	Nnake (monna oa nnake)

The kinship terms shown in the above table depict no difference between Setswana and Southern Sotho.

Table 14d

The table below contains dictionary entries for Setswana kinship terms used in Table 14a above

Term	South African Multi-language Dictionary	Setswana English Dictionary	Dikišinari ya Setswana English Afrikaans	Thanodi ya Setswana
Mogolole/Nkgonne	No entry	No entry	Elder brother or sister	Mosimane yo motona mo lwapeng a tewa ke monnawe wa mosimane
Kgaitradi	Sister	No entry	My sister (used by her brother); my brother (used by his sister)	Bolesika jwa mosetsana le mosimane ba e leng bana ba motho
Mogadibo	Sister-in-law	No entry	My husband's sister; my brother's wife	Motho yo o nyetsweng ke kgaitradiake; kgaitradi wa monna wa me
Nnake	No entry	No entry	My younger brother or sister	Ngwana wa batsadi ba me yo o tsetsweng fa morago ga me

In this table, the term 'Mogolole' or 'Nkgonne' (elder brother or sister) does not indicate gender; whether the relative referred to is male or female depends on the

gender of the speaker. This term is normally used if the speaker and the person referred to are of the same sex, otherwise the term is replaced by 'Kgaisadi' (brother or sister).

4.5 WIFE’S FATHER’S BROTHERS’ AND SISTERS’ CHILDREN

The relationship shown here is between the wife and her cousins on her father’s side. The dominant terms used in this relationship are ‘Ntsala’ (cousin) and ‘Mogolole’ or ‘Nkgonne’ (used to refer to wife’s father’s elder brother’s children). In English these relatives are all cousins.

Diagram 15

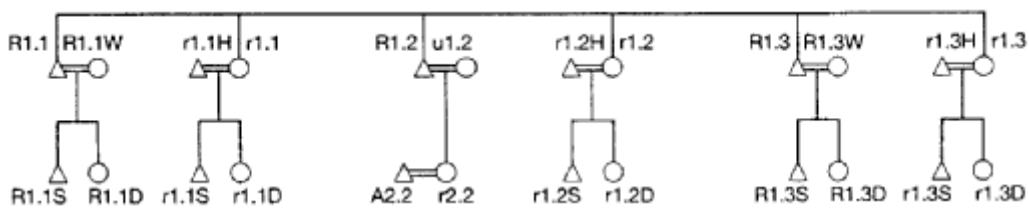

Table 15a

Relations systems of **Setswana** speakers: R-line: Two filial generations (Wife’s father’s brothers’ and sisters’ children).

Forms of address/variables (Referral terms between brackets)

F2-generation*	Ego A2.2 (male)	Ego r2.2 (female)
Older generation		
Cousin	R1.1S** Mogolole/Nnake (morwa rremogoloagwe mogatsake)	Mogolole/Nnake (ngwana wa rremogolo)
Cousin	R1.1D Mogolole/Nnake (morwadi-a-rremogolo wa mogatsake)	Mogolole/Nnake (ngwana wa rremogolo)
Cousin	r1.1S Ntsala	Ntsala(ke) (morwa rakgadi yo mogolo)
Cousin	r1.1D Ntsala	Ntsala (morwadi-a-rakgadi yo mogolo)

Younger Generation		
Cousin	R1.3S As by R1.1S Replacing 'remogolo' with 'rangwane'	As by R1.1S
Cousin	R1.3D As by R1.1D	As by R1.1S
Cousin	r1.2S As by r1.1S	As by r1.1S, replace 'yo mogolo' with 'yo monnye.
Cousin	r1.2D As by r1.1D	As by r1.1D
Cousin	r1.3S Ntsala (ke)	Ntsala
Cousin	r1.3D Ntsala	Ntsala

There is no marked difference in the pattern of kinship terms shown between Setswana, Northern Sotho and Southern Sotho.

Table 15b

Relations systems of **Northern Sotho** speakers: R-line: Two filial generations (Wife's father's brothers' and sisters' children)

Forms of address/variables (Referral terms between brackets)

F2-generation*	Ego A2.2 (male)	Ego r2.2 (female)
Older generation		
Cousin	R1.1S**Molamo (Morwa wa ramogolo wa mogatšaka)	Mogolwake/mogolle/Moratho/ Morwarre/Nnake
Cousin	R1.1D Molamo (Morwedi wa ramogolo wa mogatšaka)	Mogolwake/Moratho/ Monyanana
Cousin	r1.1S Motswala (Morwa wa rakgadi wa mogatšaka)	Motswala (Morwa wa rakgadi)

Cousin	r1.1D Motswala (Morwedi wa rakgadi wa mogatšaka)	Motswala (Morwedi wa rakgadi)
Younger generation		
Cousin	R1.3S As by R1.1S, replacing 'wa ramogolo' with 'wa rangwane'	As for R1.1S
Cousin	R1.3D As by R1.1D	As by R1.1D
Cousin	r1.2S As by r1.1S	As by r1.1S, replace 'yo mogolo' with 'yo monyane'
Cousin	r1.2D As r1.1D	As by r1.1D
Cousin	r1.3S Motswala (Morwa wa rakgadi wa mogatšaka)	Motswala (Morwa wa rakgadi yo monyenyane)
Cousin	r1.3D Motswala (Morwedi wa rakgadi wa mogatšaka)	Motswala (Morwedi wa rakgadi yo monyenyane)

(from Van Wyk and Prinsloo,

1992:56)

The pattern of kinship terms shown is the same for all the three Sotho languages.

Table 15c

Relations systems of **Southern Sotho** speakers: R-line: Two filial generations (Wife's father's brothers' and sisters' children).

Forms of address/variables (Referral terms between brackets)

F2-generation*	Ego A2.2 (male)	Ego r2.2 (female)
Older generation		
Cousin	R1.1S**Moholwane (mora oa ntatemoholo oa monna oa ka)	Moholwane (ngwana oa ntatemoholo)

Cousin	R1.1D Moholwane (moradi oa ntatemoholo oa monna oa ka)	Moholwane (ngwana oa ntatemoholo)
Cousin	r1.1S Motswala	Motswala (mora oa rakgadi ya moholo)
Cousin	r1.1D Motswala	Motswala (moradi oa rakgadi ya moholo)
Younger Generation		
Cousin	R1.3S As by R1.1S, replacing 'ntatemoholo' with 'rangwane'	As by R1.1S
Cousin	R1.3D As by R1.1D	As by R1.1S
Cousin	r1.2S As by r1.1S	As by r1.1S, replace 'ya moholo' with 'ya monnyane
Cousin	r1.2D As by r1.1D	As by r1.1D
Cousin	r1.3S Motswala	Motswala
Cousin	r1.3D Motswala	Motswala

There is no marked difference in the kinship terms used between Setswana, Southern Sotho and Northern Sotho.

Table 15d

The table below contains dictionary entries for Setswana kinship terms found in Table 15a

Term	South African Multi- language Dictionary	Setswana English Dictionary	Dikišinari ya Setswana English Afrikaans	Thanodi ya Setswana
Mogolole	No entry	No entry	Elder sister or brother	Mosimane yo motona mo lwapeng a tewa ke monnawe wa mosimane
Nnake	No entry	No entry	My younger brother or sister	Ngwana wa batsadi ba me yo o tsetsweng fa morago ga me
Ntsala	Nephew or niece	No entry	Mother's brother's child; father's sister's child	Ngwana wa malome kana rakgadi

The wife refers to her father's brothers' and sisters' children as cousins, or she can use the terms 'Mogolole' (elder brother or sister) and 'Nnake' (younger brother or sister). The term 'Ntsala' (cousin) is rightly used to refer to her father's sisters' children or mother's brother's children.

4.6 WIFE’S BROTHERS’ AND SISTERS’ CHILDREN

The diagram and tables to follow depict the relationship between the Ego’s wife (r2.2) and her nephews and nieces. The dominant terms used here are ‘Morwa’ (son) and ‘Morwadi’ (daughter). These children refer to the wife (r2.2) as aunt: her brothers’ children call her ‘Rakgadi’ (aunt) and her sisters’ children call her ‘Mmangwane’ or ‘Mmane’ (aunt).

Diagram 16

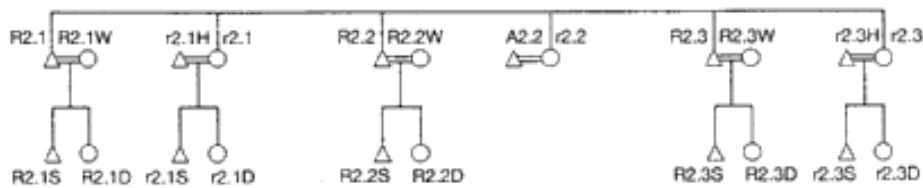

Table 16a

Relations system **Setswana** speakers: R-line: Third filial generation (Wife’s brothers’ and sisters’ children).

Forms of address/variables (Referral terms between brackets)

F2-generation*	Ego A2.2 (male)	Ego r2.2 (female)
Wife’s brothers’ children	R2.1S**Morwa (morwa-kgaitsadi-a mogatsake)	Morwa wa kgaitsadi yo mogolo
	R2.1D Morwadi-a-kgaitsadi-a-mogatsake	Morwadi-a-kgaitsadi
	R2.2S	As by R2.1S
	R2.2D	As by R2.1D
	R2.3S	As by R2.1S (with ‘yo monnye’)
	R2.3D	As for R2.1D (with ‘yo monnye’)

Wife's sisters' children	r2.1S Morwa (wa mogolowe mogatsake)	Morwa (wa mogolole)
	r2.1D Morwadi-a-mogolowe mogatsake	Morwadi-a-mogolole
	r2.3S Morwa (wa monnawe mogatsake)	Morwa (wa nnake)
	r2.3D Morwadi-a-monnawe mogatsake	Morwadi-a-nnake

The terms 'Morwa' (son) and 'Morwadi' (daughter) are used, although the relationship is not between the woman and her own children. This is so because in Setswana culture she is supposed to treat her brothers' and sisters' children as if they are her own. This is quite evident in a situation where she is responsible for their upbringing.

Table 16b

Relations systems of **Northern Sotho** speakers: K-line: Third filial generation (Wife's brothers' and sisters' children).

Forms of address/variables (Referral terms between brackets)

F2-generation*	Ego A2.2 (male)	Ego r2.2 (female)
Wife's brothers' children	R2.1S**Morwa/Motlogolo (Morwa wa kgaitšedi wa mogatšaka)	Morwa/Motlogolo (Morwa wa kgaitšedi yo mogolo)
	R2.1D Morwedi/Motlogolo (Morwedi wa kgaitšedi wa mogatšaka)	Morwedi wa kgaitšedi/wa mogolle
	R2.2S	As by R2.1S
	R2.2D	As by R2.1D

	R2.3S	As by R2.1S (with ‘yo Monyane’)
	R2.3D	As by R2.1D (with ‘yo Monyane’)
Wife’s sisters’ children	r2.1S Morwa/Motlogolo (Morwa wa mogolle wa mogatšaka)	Morwa/Motlogolo (Morwa wa mogulwake)
	r2.1D Morwedi/Motlogolo (Morwedi wa mogolle wa mogatšaka)	Morwedi/Motlogolo (Morwedi wa mogolle)
	r2.3S Morwa/Motlogolo (Morwa wa moratho/monyanana wa mogatšaka)	Morwa/Motlogolo (Morwa wa moratho/monyanana)
	r2.3D Morwedi/Motlogolo (Morwedi wa moratho wa mogatšaka)	Morwedi/Motlogolo (Morwedi wa moratho/monyanana)

(from Van Wyk and Prinsloo, 1992: 56)

The difference shown in these terms is in the spelling of ‘Morwedi’ (daughter) in Northern Sotho, while in Setswana it is ‘Morwadi’.

Table 16c

Relations system **Southern Sotho** speakers: R-line: Third filial generation (Wife’s brothers’ and sisters’ children).

Forms of address/variables (Referral terms between brackets)

F2-generation*	Ego A2.2 (male)	Ego r2.2 (female)
Wife’s brothers’ children	R2.1S**Mora (Mora-kgaitsemi oa mosadi oa ka)	Mora kgaitsemi ya moholo

	R2.1D Moradi oa kgaitsemi oa mosadi oa ka	Moradi-oa-kgaitsemi
	R2.2S	As by R2.1S
	R2.2D	As by R2.1D
	R2.3S	As by R2.1S (with ya Monnyane)
	R2.3D	As by R2.1D (with ya monnyane)
Wife's sisters' children	r2.1S Mora (oa moholwane oa mosadi oa ka)	Mora (oa moholwane)
	r2.1D Moradi (oa moholwane oa mosadi oa ka)	Moradi-a-moholwane
	r2.3S Mora (oa monyane oa mosadi oa ka)	Mora (oa monyane)
	r2.3D Moradi (oa monyane oa mosadi oa ka)	Moradi oa monyane

Table 16d

The table below contains kinship terms used in Table 16a above

Term	South African Multi-language Dictionary	Setswana English Dictionary	Dikišinari ya Setswana English Afrikaans	Thanodi ya Setswana
Morwa	Son	Son	Son	Ngwana wa motho wa mosimane
Morwadi	Daughter	Daughter	Daughter	Ngwana wa motho wa mosetsana

Only two terms are used in this table because the relationship shown is between the wife and her brothers' and sisters' children. These children are either sons or daughters of her brothers and sisters, who she treats as her own children. The man relates to these children in the same way as his wife does. The table above shows 100% treatment of the kinship terms.

4.7 WIFE'S GRANDPARENTS ON HER MOTHER'S SIDE

The relationship shown on the diagram and tables to follow is between the man's wife and her maternal grandparents. The predominant terms used in the table are 'Rremogolo' (grandfather) and 'Mmemogolo' (grandmother). The Ego (A2.2) uses the same terms as used by his wife.

Diagram 17

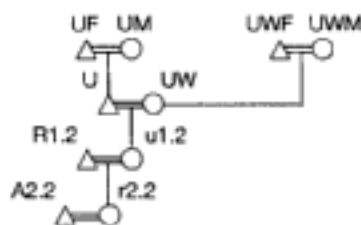

Table 17a

Relations systems of **Setswana** speakers: U-line: Parental generation (Wife's grandparents on her mother's side)

Forms of address/variables (Referral terms between brackets)

F2-generation*	Ego A2.2 (male)	Ego r2.2 (female)
Older Generation		
Great grandfathers	UF**	Ntatemogolo/Rremogolo (mmelega rremogolo)
	UWF	Ntatemogolo/Rremogolo (mmelega mmemogolo)
Great grandmothers	UM	Mmemogolo/Nkoko (mmelega rremogolo)
	UWM As by Ego r2.2 with optional addition of 'wa mogatsaka', (of my wife)	Mmemogolo/Nkoko (mmelega nkoko)
Younger Generation		
Grandfather	U	Rremogolo/Ntatemogolo (rraagwe mme)
Grandmother	UW	Mmemogolo/Nkoko (mmaagwe mme)

The optional addition of 'wa mogatsaka' or 'wa mogatsake' can be 'wa mosadi wa me'.

*Two columns for male and female forms of address and forms of referral from the F2 generation.

**Explanation of symbols appears on the diagram.

Table 17b

Relations systems of **Northern Sotho** speakers: U-line: Parental generation (Wife's grandparents on her mother's side)

Forms of address/variables (Referral terms between brackets)

F2-generation*	Ego A2.2 (male)	Ego r2.2 (female)
Older generation		
Great grandfathers	UF**	Rakgolokhukhu (Mmelega Rakgolo)
	UWF	Rakgolokhukhu (Mmelega Mmakgolo/Mmelega koko)
	UM As by r2.2 with optional addition of 'wa mogatšaka' (of my wife)	Mmakgolokhukhu (Mmelega rakgolo)
	UWM	Mmakgolokhukhu (Mmelega koko)
Younger generation		
Grandfather	U	Rakgolo/Tatemogolo (Mmelega mme)
Grandmother	UW	Mmakgolo/Koko (Mmelega mme)

(from Van Wyk and Prinsloo,

1992:57)

The optional addition of 'wa mogatšaka' (of my wife) can also be 'wa mosadi wa me' (of my wife).

*Two columns of male and female forms of address and forms of referral from the F2-generation.

Table 17c

Relations systems of **Southern Sotho** speakers: U-line: Parental generation (Wife's grandparents on her mother's side)

Forms of address/variables (Referral terms between brackets)

F2-generation*	Ego A2.2 (male)	Ego r2.2 (female)
Older Generation		
Great grandfathers	UF**	Ntatemoholo (mme oa ntatemoholo)
	UWF	Ntatemoholo (mme oa nkhono)
Great grandmothers	UM	Nkhono (mme oa ntatemoholo)
	UWM As by Ego r2.2 with optional addition of 'wa mosadi oa ka', (of my wife)	Nkhono (mme oa nkhono)
Younger Generation		
Grandfather	U	Ntatemoholo
Grandmother	UW	Nkhono

There is not much difference between the terms in the Southern Sotho table above and the other Sotho languages, except for the use of 'oa mosadi oa ka', which cannot be replaced with 'wa mogatsaka' or 'wa mogatsake'. Southern Sotho does not have the Setswana term 'mogatsa' or 'mogatša' in Northern Sotho, it uses 'monna oa ka' or 'mosadi oa ka'.

*Two columns for male and female forms of address and forms of referral from the F2 generation.

**Explanation of symbols appears on the diagram.

Table 17d

The table below contains dictionary entries for kinship terms used in Table 17a above

Term	South African Multi- language Dictionary	Setswana English Dictionary	Dikišinari ya Setswana English Afrikaans Dictionary	Thanodi ya Setswana
Ntatemogolo	Grandfather	No entry	Grandfather; father's elder brother	Rraagwe ntate
Mmemogolo	Grandmother	No entry	Grandmother; mother's elder sister	Mmaagwe mme; nkoko; mogolowe mme

These two terms in this table refer to the man's wife's grandparents as well as great-grandparents. Only one dictionary has no entry for the terms, giving the terms 80% treatment.

4.8 WIFE’S MOTHER’S BROTHERS AND SISTERS

In this relationship the wife’s husband refers to his mother-in-law’s brothers and sisters as uncles and aunts. The dominant terms used here are ‘Malome’ (uncle; mother’s brother) and ‘Mmangwane’ (aunt; mother’s sister). The other terms used, ‘Mmamalome’ (uncle’s wife) and ‘Rangwane’ (aunt’s husband), are presented to show how Ego r2.2 relates to her uncles’ and aunts’ spouses.

Diagram 18

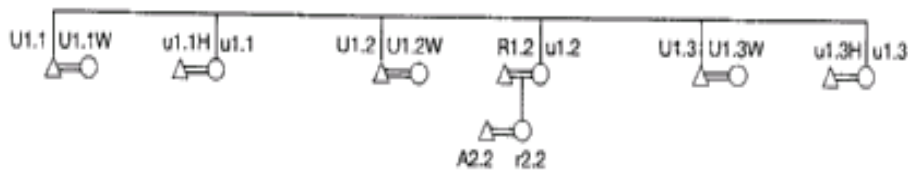

Table 18a

Relations systems of **Setswana** speakers: K-line: First filial generation (Wife’s mother’s brothers and sisters)

Forms of address/variables (Referral terms between brackets)

F2-generation*	Ego A2.2 (male)	Ego r2.2 (female)
Older Generation		
Uncle	U1.1**	Malome (yo mogolo)
Aunt	U1.1W	Mogatsa malome (mmamalome)
Aunt	u1.1	Mmemogolo
Uncle	u1.1H As by Ego r2.2 with optional addition of ‘wa mogatsake’, (of my wife)	Rremogolo (mogatsa mmemogolo)
Uncle	U1.2	Malome (yo mogolwane)
Aunt	U1.2W	Mmamalome

Younger Generation		
Uncle	U1.3	Malome (yo monnye)
Aunt	U1.3W	Mogatsa malome
Aunt	u1.3	Mmangwane/Mmane (monnawe mme)
Uncle	u1.3H	Rangwane (mogatsa mmangwane)

*Two columns for male and female forms of address and forms of referral from the F2 generation.

**Explanation of symbols appears on the diagram.

Table 18b

Relations systems of **Northern Sotho** speakers: K-line: First filial generation (Wife's mother's brothers and sisters

Forms of address/variables (Referral terms between brackets)

F2-generation*	Ego A2.2 (male)	Ego r2.2 (female)
Older generation		
Uncle	U1.1**	Malome (yo mogolo)
Aunt	U1.1W Same as for r2.2 with optional addition of 'wa mogatšaka' (of my wife)	Mogatša malome
Aunt	u1.1	Mmamogolo
Uncle	u1.1H	Ramogolo (Mogatša mmamogolo)
Uncle	U1.2	Malome (yo mogolwane)
Aunt	U1.2W	Mogatša malome

Younger generation		
Uncle	U1.3	Malome (yo monyane)
Aunt	U1.3W	Mogatša malome
Aunt	u1.3	Mmangwane
Uncle	u1.3H	Rangwane (Mogatša mmangwane)

(from Van Wyk and Prinsloo,

1992:58)

There are no marked differences in the kinship terms shown between Northern Sotho and Setswana.

*Two columns of male and female forms of address and forms of referral from the F2-generation.

Table 18c

Relations systems of **Southern Sotho** speakers: K-line: First filial generation (Wife's mother's brothers and sisters).

Forms of address/variables (Referral terms between brackets)

F2-generation*	Ego A2.2 (male)	Ego r2.2 (female)
Older Generation		
Uncle	U1.1**	Malome (ya moholo)
Aunt	U1.1W	Mosadi oa malome
Aunt	u1.1	Nkhono
Uncle	u1.1H As for Ego r2.2 with optional addition of 'oa mosadi oa ka', 'of my wife'	Ntatemoholo (monna oa nkhono)
Uncle	U1.2	Malome (yo moholwane)
Aunt	U1.2W	Mosadi oa malome
Younger Generation		
Uncle	U1.3	Malome (ya monnyane)

Aunt	U1.3W	Mosadi oa malome
Aunt	u1.3	Mmangwane
Uncle	u1.3H	Rangwane (monna oa mmangwane)

*Two columns for male and female forms of address and forms of referral from the F2 generation.

**Explanation of symbols appears on the diagram.

Table 18d

The table below shows kinship terms found in Table 18a

Term	South African Multi-language Dictionary	Setswana English Dictionary	Dikišinari ya Setswana English Afrikaans	Thanodi ya Setswana
Malome	Uncle	No entry	Mother's brother	Kgaitadi'a mmaagwe motho
Mmemogolo	Grandmother	No entry	Grandmother; mother's elder sister	Mmaagwe mme; nkoko; mogolowe mme
Mmangwane	No entry	No entry	Mother's younger sister	Monna'a mme
Rangwane	No entry	My uncle	Father's younger brother	Monnawe ntate

The term 'Mmemogolo' (grandmother) is used here to refer to the wife's mother's elder sister, not her mother. 'Rangwane' (father's younger brother) is used here to refer to the aunt's husband. There is 60% treatment of the terms, which is satisfactory.

4.9 WIFE’S MOTHER’S BROTHERS’ AND SISTERS’ CHILDREN

The diagram and tables below show the relationship between the man’s wife (Ego r2.2) and her cousins on her mother’s side. The most dominant terms here are ‘Ntsala’ (cousin), ‘Mogolole’ or ‘Nkgonne’ (elder sister) and ‘Nnake’ (younger sister or brother). The man (A2.2) in this case uses the same terms as used by his wife, with the optional addition of ‘wa mogatsake’ (of my wife).

Diagram 19

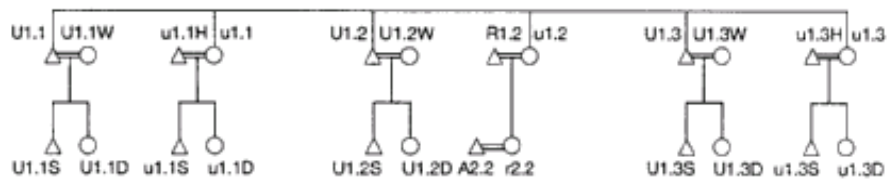

Table 19a

Relations systems of **Setswana** speakers: U-line: Second filial generation (Wife’s mother’s brothers’ and sisters’ children).

Forms of address/variables (Referral terms between brackets)

F2-generation*	Ego A2.2 (male)	Ego r2.2 (female)
Older generation		
Cousin	U1.1S** Ntsalake (morwa wa malomaagwe mogatsake)	Ntsalake (ngwana wa malome yo mogolo)
Cousin	U1.1D Ntsalake (morwadi-a- malomaagwe mogatsake)	Ntsalake (ngwana wa malome yo mogolo)
Cousin	u1.1S Mogolole (ngwana wa ga mmemogolo wa mogatsake)	Kgaitadiake/Mogolole (ngwana wa ga mmemogolo)

Cousin	u1.1D Mogolole/Nkgonne (ngwana wa ga mmemogolo wa mogatsake)	Mogolole (ngwana wa ga mmemogolo)
Cousin	U1.2S As by U1.1S	As by U1.1S
Cousin	U1.2D As by U1.1D	As by U1.1D
Younger Generation		
Cousin	U1.3S As by U1.1S	As by U1.1S (with ‘yo monnye’ instead of ‘yo mogolo’)
Cousin	U1.3D As by U1.1D	As by U1.1D
Cousin	u1.3S Mogolole/Nnake (ngwana wa ga mmangwane wa mogatsake)	Mogolole/Nnake/Kgaitradi (ngwana wa ga mmangwane)
Cousin	u1.3D Mogolole/Nnake	Mogolole/Nnake (ngwana wa ga mmangwane)

The terms ‘Mogolole’ or ‘Nkgonne’ (elder sister) and ‘Nnake’ (younger sister or brother) as used in the table above refer to the mother’s elder sister’s children or younger sister’s children respectively. There are no single terms used for this relationship except the expression ‘Ngwana wa ga mmemogolo’ (mother’s elder sister’s child).

*Two columns for male and female forms of address and forms of referral from the F2-generation.

**Explanation of symbols appears on the diagram.

Table 19b

Relations systems of **Northern Sotho** speakers: U-line: Second filial generation

(Wife’s mother’s brothers’ and sisters’ children

Forms of address/variables (Referral terms between brackets)

F2-generation*	Ego A2.2 (male)	Ego r2.2 (female)
Older generation		
Cousin	U1.1S**Motswala (Morwa wa malome wa mogatšaka)	Motswala/Motswalake (Morwa wa malome yo mogolo)
Cousin	U1.1D Motswala (Morwedi wa malome wa mogatšaka)	Motswala (Morwedi wa malome yo mogolo)
Cousin	u1.1S Motswala	Motswala/Nnake/Kgaitšedi (Morwa wa mmamogolo)
Cousin	u1.1D Motswala	Motswala/Moratho/Monyanana (Morwedi wa mmamoglo)
Cousin	U1.2S As by U1.1S	As by U1.1S
Cousin	U1.2D As by U1.1D	As by 1.1D
Younger generation		
Cousin	U1.3S As by U1.1S	As by U1.1S (replace 'yo mogolo' with 'yo monyane')
Cousin	U1.3D As for U1.1D	As for U1.1D
Cousin	u1.3S As by u1.1S	As by u1.1S (replace 'wa mmamogolo' with 'wa mmangwane')
Cousin	u1.3D As by u1.1D	As above

(from Van Wyk and Prinsloo, 1992:58)

The only difference shown by the above table is the use of the Sepedi term 'Motswala' (cousin) where Setswana uses 'Ntsala(ke)' (cousin). For both languages, the terms 'Mogolole', 'Nnake', 'Kgaitšadi' (brother or sister) can be used to refer to mother's sisters' children.

*Two columns of male and female forms of address and forms of referral from the F2-generation.

Table 19c

Relations systems of **Southern Sotho** speakers: U-line: Second filial generation
(Wife's mother's brothers' and sisters' children).

Forms of address/variables (Referral terms between brackets)

F2-generation*	Ego A2.2 (male)	Ego r2.2 (female)
Older generation		
Cousin	U1.1S** Motswala (mora oa malome oa mosadi oa ka)	Motswala (ngwana oa malome ya moholo)
Cousin	U1.1D Motswala (moradi oa malome oa mosadi oa ka)	Motswala (ngwana oa malome ya moholo)
Cousin	u1.1S Moholwane (ngwana oa nkho oa mosadi oa ka)	Kgaitsemi (ngwana oa nkho)
Cousin	u1.1D Moholwane	Moholwane (ngwana oa nkho)
Cousin	U1.2S As by U1.1S	As by U1.1S
Cousin	U1.2D As by U1.1D	As by U1.1D
Younger Generation		
Cousin	U1.3S As by U1.1S	As by U1.1S (with 'ya monnyane' instead of 'ya moholo')
Cousin	U1.3D As by U1.1D	As by U1.1D
Cousin	u1.3S Moholwane (ngwana oa mmangwane wa mosadi oa ka)	Moholwane/Kgaitsemi (ngwana oa mmangwane)
Cousin	u1.3D Moholwane	Moholwane (ngwana oa mmangwane)

*Two columns for male and female forms of address and forms of referral from the F2-generation.

**Explanation of symbols appears on the diagram.

Table 19d

Below is a table showing kinship terms used in Table 19a above

Term	South African Multi-language Dictionary	Setswana English Dictionary	Dikišinari ya Setswana English Afrikaans	Thanodi ya Setswana
Ntsala	Nephew or niece	No entry	Mother's brother's child; father's sister's child	Ngwana wa ga malome kana rakgadi
Mogolole/nkgonne	No entry	No entry	Elder brother or sister	Mosimane yo motona mo lwapeng a tewa ke monnawe wa mosimane
Nnake	No entry	No entry	My younger brother or sister	Ngwana wa batsadi ba me yo o tsetsweng fa morago ga me

The dictionary entry for 'Mogolole' or 'Nkgonne' (elder brother or sister) in Setswana shows that the term refers to a male only, but in reality it can also refer to a female, as long as the person referred to is older than the speaker. In this table, the terms 'Nkgonne' (elder brother or sister) and 'Nnake' (younger brother or sister) are used to refer to uncles' and aunts' children, not the man's wife's own brothers and sisters.

4.10 CONCLUSION

This chapter is similar to the preceding one, except that it focuses on the wife's relatives. Most of the terms that the Ego's wife (r2.2) uses to refer to her relatives are the same as those used by the Ego (A2.2) referring to his relatives. The relations shown in this chapter can be divided into three groups. The first group is that of the relatives of the woman (Ego r2.2) on her father's side, that is, her paternal relatives. The second group deals with relatives on her mother's side, her maternal relatives. The last group is that of the woman's own brothers and sisters (and their children). As in the preceding chapter, kinship terms may be repeated in the different groups mentioned earlier. In that trend, Tables 12a and 17a contain similar terms, with the latter illustrating maternal relatives while the former shows paternal relatives. Tables 13a and 18a follow the same trend. The wife's cousins are found in Tables 15a and 19a, paternal and maternal respectively. Table 14a contains the wife's brothers and sisters while Table 16a shows their children.

Basically, all patterns of kinship terminology for the three Sotho languages are similar so that the trend used for the Setswana tables is also applicable to Northern Sotho and Southern Sotho. The major difference is the use of the term 'Mogwegadi' (my wife's parent) as used by the man to refer to his wife's parents (see Table 13a). The woman would use the terms 'Matsale' (mother-in-law) and 'Ratsale' (father-in-law) in Setswana. These terms, 'Matswale' and 'Ratswale' in Northern Sotho, are used by both the woman and the man referring to their mothers-in-law and fathers-in-law respectively. In Southern Sotho the parents-in-law are simply referred to as mother and father. There are minor differences, such as the spelling of the terms 'Morwadi' (daughter) in Setswana, which is 'Morwedi' in Northern Sotho and 'Moradi' in Southern Sotho.

In this chapter, the treatment of kinship terms in the dictionaries is satisfactory. Only one dictionary, Setswana English Dictionary by Brown (1973) has no entries for kinship terms.

CHAPTER 5

A GLOSSARY OF SETSWANA KINSHIP TERMS

5.1 INTRODUCTION

In this chapter, the researcher has made an attempt to come up with a glossary of some kinship terms. Most of the meanings came from two Setswana dictionaries, Thanodi ya Setswana by Kgasa & Tsonope (1995), and Dikišinari ya Setswana English Afrikaans by Snyman, Shole and le Roux (1990). The researcher provided those terms that were not treated in the dictionaries, based on her own knowledge of the language as a native Setswana speaker. The researcher could not come up with a glossary of kinship terms from the other Sotho languages included in the study because the focus in this study is on Setswana kinship terms, although it is done in a comparative manner. The terms included in this chapter are not arranged in any particular order.

For each term treated, the researcher followed the format employed by Kgasa and Tsonope in the dictionary Thanodi ya Setswana (1995) where the word class is given. All the terms in this chapter are nouns (maina) hence the noun classes are shown as 'setlhopha'. The intonation pattern is also shown, for example, T for low tone syllable (segalo tlase), and G for high tone syllable (segalo godimo). Generally all the kinship terms in Setswana fall under class 1 or 1a as is clear from the glossary that follows.

5.2 TERMS

Term	English term	Source
Mogadibo (leina) (setlhopha 1a) TGGG. motho yo nyetsweng ke kgaitsadiake, kgotsa kgaitsedi wa monna wa me.	Sister-in-law	Thanodi ya Setswana Kgasa & Tsonope (1995:161)

Term	English term	Source
Nkgonne TGTG (leina) (setlhopha 1a) motho yo tsetsweng pele ga me.	Elder brother/sister	Thanodi ya Setswana Kgasa & Tsonope (1995:194)
Mmamalome TGTGT (leina) (setlhopha 1a) mosadi wa ga malome .	Maternal uncle's wife	Own knowledge
Kgaityadi GTGG (leina) (setlhopha) 1a bolesika jwa mosetsana le mosimane ba eleng bana ba motho.	Brother/sister	Thanodi ya Setswana Kgasa & Tsonope (1995: p88)
Rangwane GTG (leina) (setlhopha 1a) monnawe ntate wa senna.	Father's brother, uncle	Thanodi ya Setswana Kgasa & Tsonope (1995: 228)
Mogatsa nnake TGG GTT (expression) monna (kgotsa mosadi) wa ga nnake.	Brother-in-law or sister-in-law	Own knowledge
Motlogolo TGTT (leina) (setlhopha 1) ngwana wa ga kgaityadiake.	My sister's child (used by her brother or his wife)	Snyman, Shole, Le Roux (1996:99)
Ngwetsi TG (leina) (setlhopha 1a) mosadi wa morwaake.	Daughter-in-law	Snyman, Shole, Le Roux (1996:107)
Mmemogolo TGTGT (leina) (setlhopha 1a) mmaagwe/mmelega-mme. Le ka raya mogolowe mme wa sesadi.	Grandmother	Snyman, Shole, Le Roux (1996:94)
Morwa TG (leina) (setlhopha 1) ngwana wa mosimane.	Son	Snyman, Shole, Le Roux (1996:98)
Rakgadi GTG (leina) (setlhopha 1a) kgaityadi wa ga ntate, le monna wa gagwe.	Aunt, father's sister or her husband	Snyman, Shole, Le Roux (1996:135)
Ratsale TTT(leina) (setlhopha 1a) Motsadi wa monna wame wa senna.	Father-in-law	Own knowledge

Rremogolo TGTGT (leina) (setlhopha 1a) monna yoo nyetseng mmemogolo.	Mother's elder sister's husband	Own knowledge
--	------------------------------------	---------------

5.3 CONCLUSION

This glossary, compiled from different dictionaries, can assist a language learner in a satisfactory manner. The researcher has made an input by providing definitions for some Setswana expressions not treated in dictionaries. This is especially helpful in cases of ambiguity, since the definition in the dictionary may not be the only meaning for a kinship term.

CHAPTER 6

SUMMARY, RECOMMENDATIONS AND CONCLUSION

6.1 INTRODUCTION

This study was motivated by the need to establish a systematic approach to the usage and treatment of kinship terms in Setswana dictionaries as well as in daily usage. In Chapter 2, there are different interpretations of what constitutes kinship. The roles played by the people assigned these terms also differ in interpretation according to different cultures.

6.2 SUMMARY OF THE STUDY

6.2.1 The quality of entries

The treatment of kinship terms in dictionaries, especially Sotho dictionaries seems to be insufficient. This can be attributed to the fact that some entries are mere translations from either English or Afrikaans. As a result, there is only one word given as a meaning for a particular kinship term. For instance, The South African Multi-language Dictionary (1996) gives translations of terms from their English counterparts, for example, the meaning of 'mmemogolo', is given as 'grandmother'. The production of good dictionaries like of Thanodi ya Setswana by Kgasa and Tsonope (1995) should be encouraged. The only problem with this work is its volume, it is too small, it does not include all Setswana words, hence certain kinship terms are not dealt with.

Another issue that has not been satisfactorily taken into consideration in the dictionary entries is that of ambiguity. Certain terms can be used to refer to more than one relation, but dictionaries only show part of the meaning.

6.2.2 Issues raised in the problem statement

Research has shown that not all kinship terminology exists because there are cases where expressions are used to refer to relatives. For instance, there is no specific term for a man's wife's sister's child. Instead, the expression 'Ngwana wa ga nkgonne' (my elder sister's child) is used.

As far as the dynamic nature of language is concerned, kinship terminology in Setswana has not received much attention in terms of development. It looks like language bodies or committees are only concerned with the status of language as a whole, not with looking at certain components of language like kinship terminology. It is because of this characteristic lack of development that a foreigner only has to practise the use of terms which do not denote gender until he or she grasps the context.

When looking at the use of borrowed kinship terms, they are dominant in areas where natives live with speakers of other languages. The environment contributes a lot to the use of borrowed words. The Northern Sotho speakers use many terms originating from Afrikaans because these people live amongst each other. But when we look at Setswana, the terms used are mostly native and original terms because there is little or no interference from other languages in the vicinity. An example of a borrowed kinship term in Northern Sotho would be 'Abuti' meaning 'elder brother', (borrowed from the Afrikaans term 'boetie') where Setswana would use 'mogolole' or 'nkgonne' for the same meaning.

Generally, the researcher believes that the borrowed kinship terms should be treated in dictionaries because some of them are very commonly used in certain communities. This can help a foreigner who settles in such a community with the intention of learning the language. The learner can consult a dictionary written in that particular language and find the terms defined accordingly.

6.3 RECOMMENDATIONS

Having completed this detailed study on kinship terminology, the researcher makes the following recommendations directed to all writers, students as potential writers, as well as lexicographers.

1. All bodies and individuals who intend to produce dictionaries should include kinship terms, as these are often overlooked.
2. When tackling kinship terminology in the dictionaries, the aspect of ambiguity must be dealt with, lest a language learner be misled to think that a particular term can only be used as it appears in a particular dictionary.
3. Since borrowing is inevitable in any given language, borrowed kinship terms must be treated in dictionaries. This is proof that Setswana, like other languages, is dynamic.
4. Writers must make sure they include in their work some glossary which should address, among others, kinship terms.
5. Writers and prospective writers need to produce dictionaries specifically addressing kinship terminology, especially in Setswana.
6. Those who have come up with monolingual entries of Setswana kinship terms in their dictionaries should include translations of such terms into languages that are internationally recognised in their new editions.

6.4. CONCLUSION

In conclusion, although much remains to be done, this research has opened a whole new field which was not treated satisfactorily until now. Having looked at the problems that might have contributed to little or no coverage of kinship terms in the Setswana dictionaries, the researcher has concluded that the entries in the used dictionaries are satisfactory. The main aspect that was not satisfactorily treated is that of ambiguity. Only two dictionaries, *Thanodi ya Setswana* by Kgasa and Tsonope (1995) and *Dikišinari ya Setswana English Afrikaans* by Snyman, Shole and le Roux (1990), that have attempted to give more than one meaning for any given lexical item.

It would be worthwhile if more research could be done on the subject, probably using different approaches since the researcher here used the standard method employed by Van Wyk and Prinsloo (1992) when they studied Northern Sotho kinship terminology. On monolingual publications, the researcher is skeptical because of the international status of Setswana as a language, that is, it can only be understood by people around Southern Africa. Furthermore, the findings of this study will serve as a basis for those who would like to pursue research in the field of lexicography in general.

BIBLIOGRAPHY

- BOONZAAIER, C. (undated article). *Kinship Terminology among the South-Eastern Bantu*. Pretoria: University of Pretoria.
- ESHLEMAN, J.R. 1994. *The Family- An Introduction*. Massachusetts: Simon and Schuster Inc.
- GOODY, J. (editor) 1973. *The Character of Kinship*. Great Britain: Cambridge University Press.
- GOVE, P. B. 1967. *The Role of the Dictionary*. New York: The Boss-Merril Company, Inc.
- HARTMANN, R.R.K. 2001. *Teaching and Researching Lexicography*. England: Pearson Education Limited.
- HOLY, L. 1998. *Anthropological Perspectives on Kinship*. London: Pluto Press.
- KEESING, R. M. 1975. *Kin Groups and Social Structure*. New York: Holt, Rinehart and Winston.
- KIANGO, J. G. 2000. *Bantu Lexicography: A Critical Survey of the Principles and Process of Constructing Dictionary Entries*. Tokyo: ILCAA (Institute for the study of Language and Cultures of Asia and Africa).
- MOGAPI, K. 1991. *Ngwao ya Setswana*. Mabopane: L.Z Sikwane Publishers.
- RADCLIFFE-BROWN, A.F. and FORDE 1968. *African Systems of Kinship*. London: Oxford University Press

- RAMAGOSHI et al 2000. *Ubuntu/Botho for the Corporate World*. Pretoria: University of Pretoria.
- SCHAPER, I. & COMAROFF J. L 1991. *The Tswana*. London & New York: Oxford University Press.
- STONE, L. 1998. *Kinship and Gender: an Introduction*. Oxford: Westview Press.
- SCHUSKY, E. L. 1972. *Manual for Kinship Analysis-2nd edition*. New York: Holt, Rinehart and Winston.
- SCHUSKY, E.L. 1974. *Variation of Kinship*. New York: Holt, Rinehart and Winston.
- Van WYK, J.J. & PRINSLOO, D.J. 1992. Verwantskapsterminologie van die Noord-Sotho. In: *South African Journal of African Languages*, Vol. 15, No. 2, p 43-58.

LIST OF DICTIONARIES

- BROWN, J. T. 1973. *Setswana English Dictionary* Gaborone: Botswana Book Centre.
- HAMEL, L. and O.M.I. 1965. *English-Southern Sotho Dictionary – Part six, I-Z*, Basutoland: The Catholic Centre.
- JENNINGS, L.E. et al. 1995. *The Concise Multi-lingual Dictionary*. Johannesburg: Ad. Donker Publishers.

- KGASA, M. 1981. *Thanodi ya Setswana ya Dikolo*, Cape Town: Longman Penguin Southern Africa (Pty) Ltd.
- KIRKPATRICK, M. A. (ed) 1981. *Chambers Family Dictionary*, Edinburgh: W & R Chambers Ltd
- le ROUX, J.C. et al. 1996. *South African Multi-language Dictionary and Phrase Book*, Cape Town: S A The Readers' Digest Association (Pty) Ltd.
- LONGMAN GROUP 1992. (edi) *Longman Dictionary of English Language and Culture*. Essex: England UK Limited.
- LONGMAN 1990. *Longman Dictionary of Contemporary English, New edition*. Essex: Longman.
- MATHUMO, Z. I. 1987. *Setswana English Setswana Dictionary*. Gaborone: Macmillan Botswana Publishing Company.
- SHAW, H. 1987. *Dictionary of Problem Words and Expressions*. New York: McGraw-Hill Book Company.
- SNYMAN, J.W., SHOLE, J.S & le ROUX, J. C 1990. *Dikišinari ya Setswana English Afrikaans*. Pretoria: Via Africa Limited.
- THOMOSON, D. 1995. (edi) *The Concise Oxford Dictionary*. Oxford. Clarendon Press.
- KGASA, M.L.A. & TSONOPE, J. 1995. *Thanodi ya Setswana*. Gaborone: Longman.

SOURCES

- BARNARD, A. & GOOD, A. 1984. *Research Practices in the Study of Kinship*. London: Academic Press
- GUMA, S.M. 1972. *An Outline Structure of Southern Sotho*. Pietermaritzburg: Shuter and Shooter.
- MAIR, L. 1969. *African Marriage and Social Change*. London: Frank Cass & Co. Ltd
- MIDDLETON, J. and RASSAM, A. 1995. *Encyclopedia of World Cultures*. Boston: G.K Hall & Co. Ltd
- MILLER, B.C. 1986. *Family Research Methods*. California: SAGE Publications, Inc.
- MONNIG, H.O. 1967. *The Pedi..* South Africa: Van Schaick.
- MURDICK, G.P. 1949. *Social Structure*. New York: Macmillan
- STEINMETZ, S.K., CLAVAN, S & STEIN, K.M. 1990. *Marriage and Family Realities- Historical and Contemporary Perspectives*. New York: Harper and Row Publishers.
- THOMPSON, L. 1972. *African Societies in Southern Africa – Historical Studies*. London: Heinemann.
- Van WARMELO, N.J. 1931. *Kinship Terminology of South African Bantu*. Pretoria: The Government Printer.
- WOOKEY, A.J. 1929. *Dico tsa Setswana*. Not found.

KEY

△ = Male

○ = Female

QUESTIONS

1. From the grandson's point of view, fill in the kinship terms that are used to refer to all members of the family above.
2. What term does Son 2 use to refer to Son 1? **Nkgonne/Mogolle**
3. What is the relation between Son 2 and Son-in-law 1? **Mogatsa kgaitsadiake**
4. What term does Son 2 use to refer to the wife of the grandson? **Ngwetsi**

Family Table 2

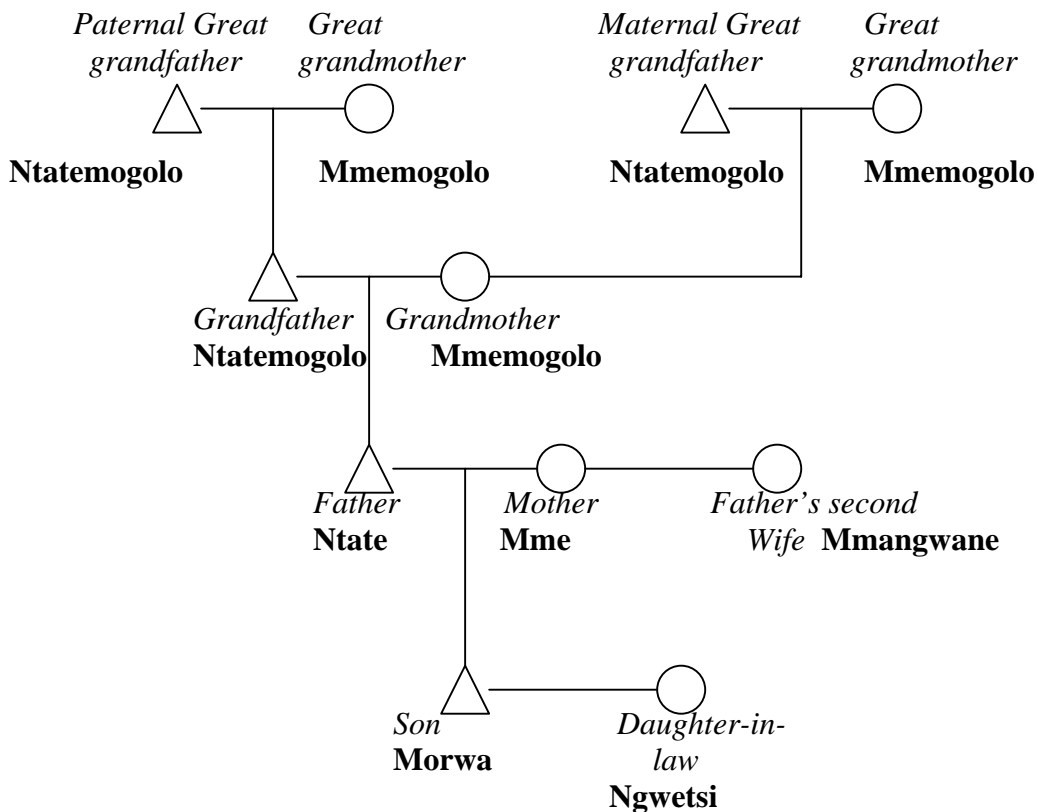

Key

△ = Male

○ = Female

Question

Replace all kinship terms in the diagram above with their counterparts in your mothertongue.

Family diagram 2

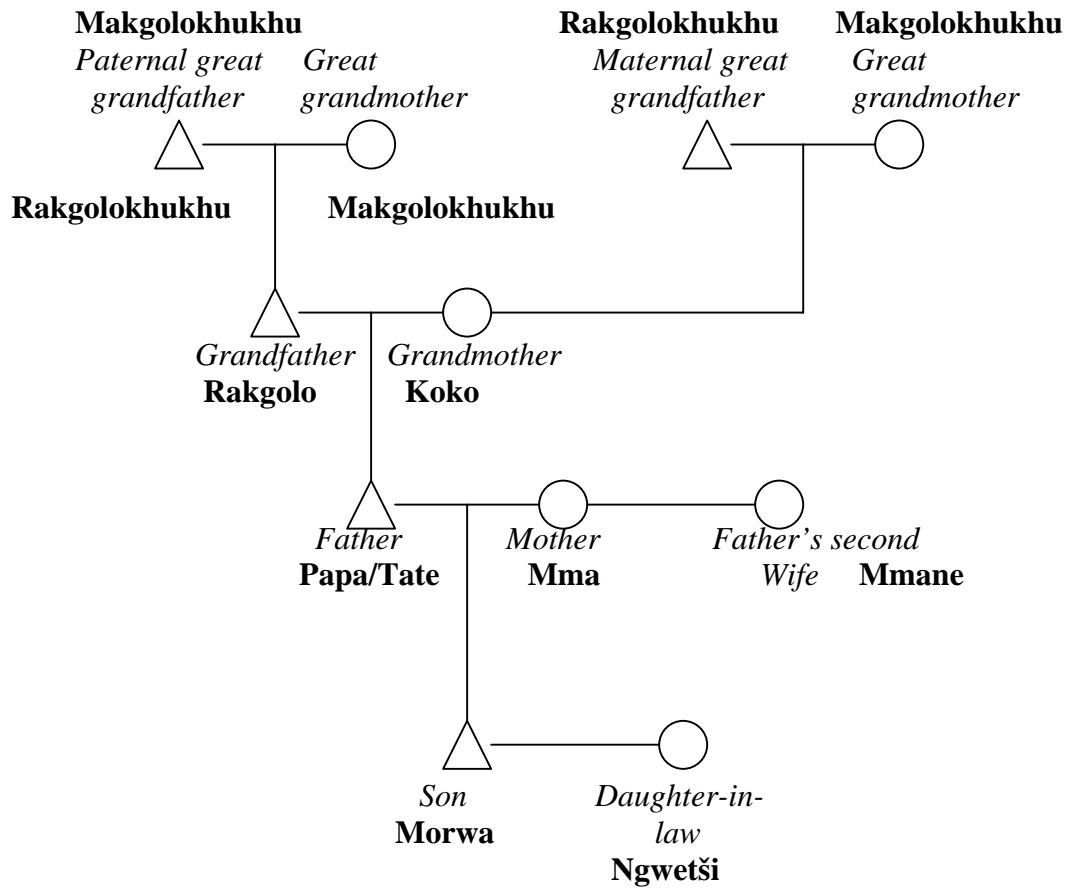

Key

△ = Male

○ = Female

Question

Replace all kinship terms in the diagram above with their counterparts in your mothertongue.

4. QUESTIONNAIRE BY SOUTHERN SOTHO RESPONDENT

Family diagram 1

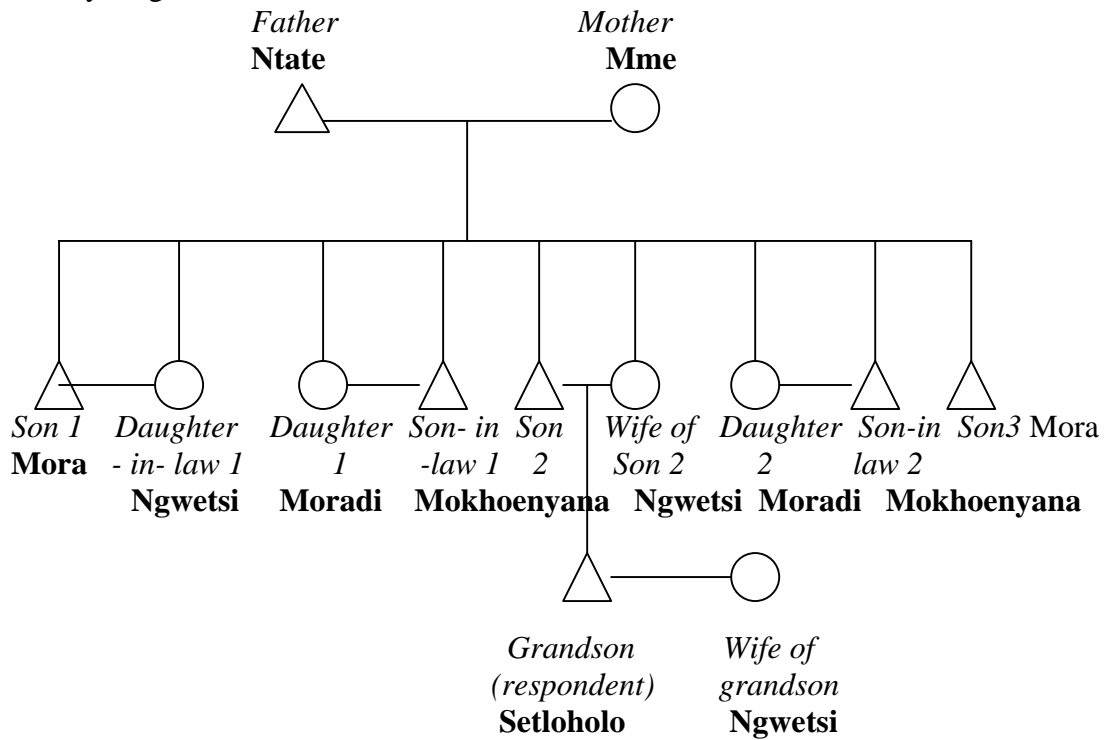

KEY

△ = Male

○ = Female

Questions

1. From grandson's point of view, fill in the kinship terms that are used to refer to all members of the family above.
2. What term does Son 2 use to refer to Son 1? **Moholwane**
3. What is the relation between Son 2 and Son-in-law 1? **Soare**
4. What term does Son 2 use to refer to the wife of the grandson? **Ngwetsi**

Family diagram 2

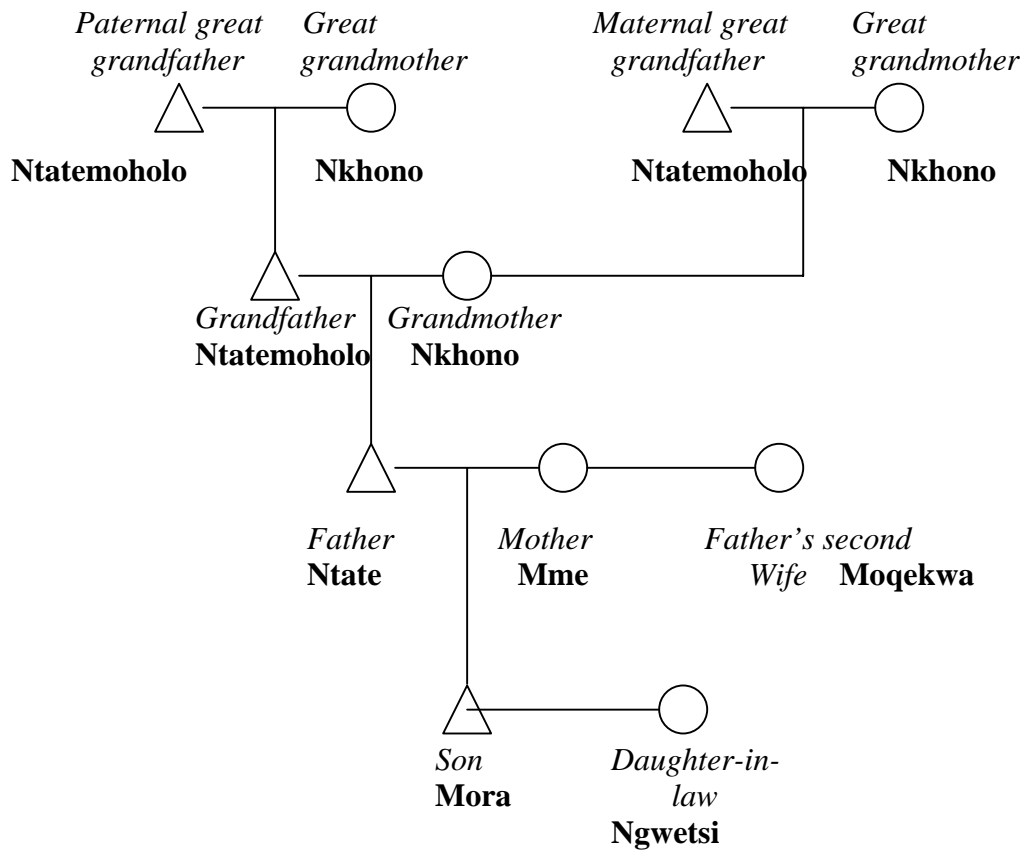

Key

△ = Male

○ = Female

Question

Replace all kinship terms in the diagram above with their counterparts in your mothertongue.